

# IoT WIRELESS MEASURING INSTRUMENTS

Powered by Sigfox network



- **Measuring and monitoring**
  - Temperature
  - Humidity
  - CO<sub>2</sub>
  - Dew point
  - Bar. pressure
  - Two-state inputs
  - Voltage input
- **Alarm signalisation**
- **Data transmitting via Sigfox network**





## SIGFOX Internet of Things (IoT) The world's leading service provider

The Sigfox network is used to transmit very short data messages and is optimized for low power consumption. It operates in the unlicensed radio band, which brings cheaper traffic, but also legislative restrictions - messages can not be sent faster than with a 10 minute interval. Operation is possible in Europe, Iran, Oman and South Africa (radio configuration zone is RC1). For current network deployment please see [www.sigfox.com](http://www.sigfox.com)

### Technology allows devices to communicate:

- **economically**
  - modem integrated into COMET devices is significantly cheaper than other technologies and does not need a SIM card
  - due to the use of unlicensed band the cost of operation is very low
- **safely**
  - all communication is signed and also hashed
  - extraordinary resistance to interference - each message is broadcasted three times at random frequency and received by all base stations in the neighborhood
- **at minimal energy consumption**
  - the modem has a power consumption of only 50 mA during transmitting and still has no consumption
  - the battery life is up to 8 years according to the time interval of data transmission
- **for long distances**
  - a typical range of direct visibility is 200 km, 50 km in the open countryside and in dense urban areas 3-5 km
  - quick construction of coverage across countries



## COMET Cloud Measured data where you need

COMET Cloud is the internet storage of data measured by COMET sensors. Data are accessible in the internet and displayed in an internet browser. Every user has the access to his account COMET Cloud protected by password. COMET Cloud enables to add sensors, creates organisational structures such sensor groups and user groups. The different rights can be set up for displaying and administration for each user.

- **unlimited space for data**
- **management and organization of**
  - equipments
  - measured points
  - users and their access rights
- **e-mail alarming when**
  - exceeding alarm limits with the option define recipients according to the level of exceedance
  - a fault occurs (low battery, loss of battery) radio connection, measurement error)
- **easy report creating**
- **device setup from COMET Cloud (only once a day)**

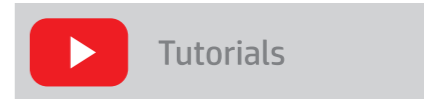

**How to** create account  
**How to** add device  
**How to** set role – administrator/user  
**How to** create measured place  
 Try GUEST access at  
<https://cometsystem.cloud/device/list>

### Four steps for getting your measured data into COMET Cloud

#### 1. Mounting sensor

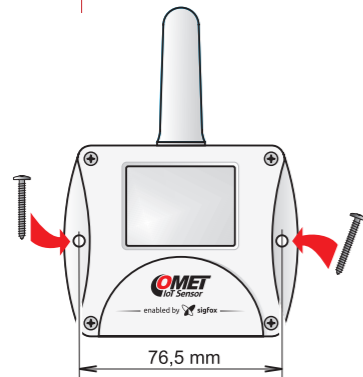

#### 2. Pressing the activation button

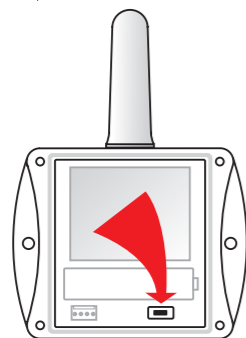

#### 3. Data is sent to COMET Cloud



#### 4. Creating COMET Cloud account and sensor registration







## Internet of things sensors



The sensor performs a measurement every 1 minute. The measured values are displayed on the LCD and are sent over an adjustable time interval (10 min to 24 hour) via radio transmission in the SIGFOX network to the cloud data store.



For each measured variable, it is possible to set two alarm limits. The alarm is signalled by the symbols on the LCD display and sending an extraordinary radio message to the SIGFOX network, where it is forwarded to the end user by e-mail.



These sensors are designed with increased resistance to external influences - especially water protection.



## Alarm functions

- two alarms can be set for each measured quantity
- each alarm has an adjustable limit, direction of exceeding the limit, delay (0-1-5-30 min) and hysteresis
- the content of both regular and extraordinary alarm messages is identical, both contain the measured values of all channels and current alarm states on all channels

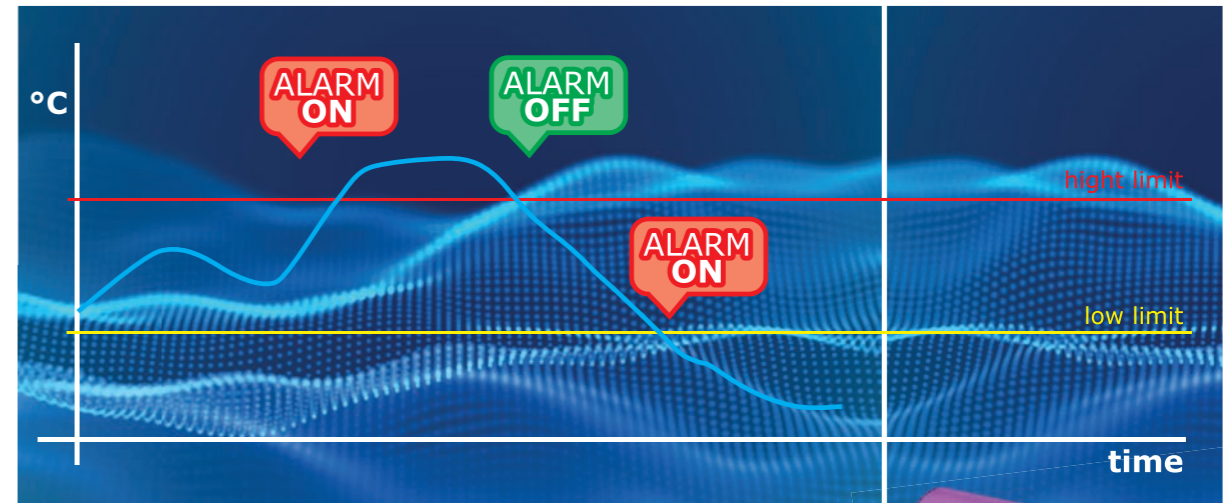

### Battery powered

The device is powered by an internal Lithium battery whose lifetime is dependent on the transmission range and operating temperature. The battery operation lifetime is from 4 months to 8 years.



**A4203**  
Lithium battery 3,6V/AA.



### Adapter for external power supply

**SP014** - Adapter SP014 together with power adapter of voltage 3.6 - 14.5 V DC can be also powered from an external large capacity battery, or a suitable solar battery system with a backup battery. The transducer with mounted adapter is designed for indoor or covered environment.

### Mounting accessories

**SP102** - Holder for mounting the COMET Transmitter on magnetic surfaces.

The kit includes two powerful neodymium magnets with a finish that reliably holds device including probes to magnetic metal surfaces as fridges or freezers.



measured values			temperature		temperature, relative humidity	temperature, relative humidity, atm. pressure		temperature, two-state			
SIGFOX SENSOR MODELS			W0810	W0811	W0832	W3810	W3811	W7810	W7811	W0850	
temperature	internal	range	-30 to +60 °C	-	-30 to +60 °C	-30 to +60 °C	according to the probe	-30 to +60 °C	according to the probe	-30 to +60 °C	
		accuracy	±0.4 °C	-	±0.4 °C	±0.4 °C		±0.4 °C			
	external	range	-	-90 to +260 °C	-90 to +260 °C	-	according to the probe	-	according to the probe	-	
		accuracy	-	±0.2°C *	±0.2°C *	-					
relative humidity**		range				0 to 100 % RH			0 to 100 % RH		
		accuracy***				± 1.8% RH **	± 1.8% RH **		±1.8% RH **	± 1.8% RH **	
dew point		range ****				-60 to +60 °C	according to the probe		-60 to +60 °C	according to the probe	
barometric pressure		range						600 to 1100 hPa	600 to 1100 hPa		
		accuracy						±1.3 hPa	±1.3 hPa		
two-state input										2 x	
sending interval / typical battery life			10 min / 4 months;	20 min / 7 months;	30 min / 11 months;	1 h / 1.5 year;	3h / 3.5 years;	6 h / 5 years;	12 h / 6 years;	24 h / 7 years	
class of protection of case with electronics / sensors			IP65		IP65 / IP40		IP54 / IP40		IP65		

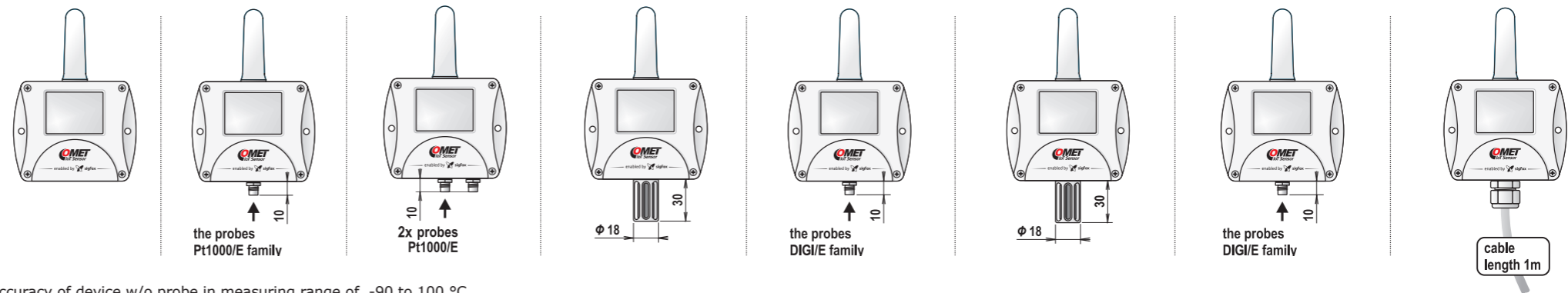
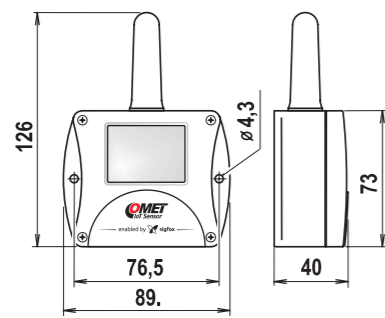

### External temperature probes

For more details see page 10.

\* accuracy of device w/o probe in measuring range of -90 to 100 °C (in range +100 to +260 °C is accuracy ±0,2 % of measured value)  
 \*\* from 0 to 90 %RH at 23 °C  
 \*\*\* accuracy of sensing element  
 \*\*\*\* for accuracy of dew point see graphs at device manual

### External temperature/humidity probes

### Sensor covers for external probes

Ultra thin digital probe.



DIGIH/E  
(-10 to +60 °C; 0 to 100% RH)

Low cost probe without filter mesh.

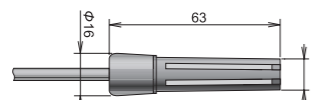

DIGIS/E  
(-10 to +60 °C; 0 to 95% RH)

Probe with interchangeable protection filter.

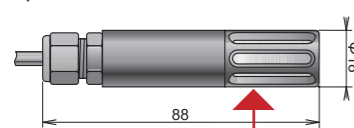

DIGIL/E  
(-30 to +105 °C; 0 to 100% RH)



**F5300** - Teflon (PTFE) sensor cover (white colour), with increased resistance against splashing water, non-absorbent surface, does not rust. Porous size 25µm. Temperature range -40°C to +125°C.

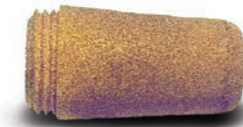

**F0000** - sintered bronze sensor cover for moderate aggressive environments. Filtering ability 0.025mm.



**F5200B** - sensor cover with filter from stainless steel mesh, suitable for moderately dusty environment. Filtering ability 0.025 mm.

### Typical battery life

Sending interval (min/hour)	standard lithium battery	battery holder (SP015) for	
	A4203	battery A4206	
	1 x battery	1 x battery	2 x batteries
10 m	4 months	1 year	2 years
20 m	7 months	2 years	4 years
30 m	11 months	3 years	6 years
1 h	1.5 years	5 years	10 years
3 h	3.5 years	10 years	> 10 years
6 h	5 years	> 10 years	> 10 years
12 h	6 years	> 10 years	> 10 years
24 h	7 years	> 10 years	> 10 years

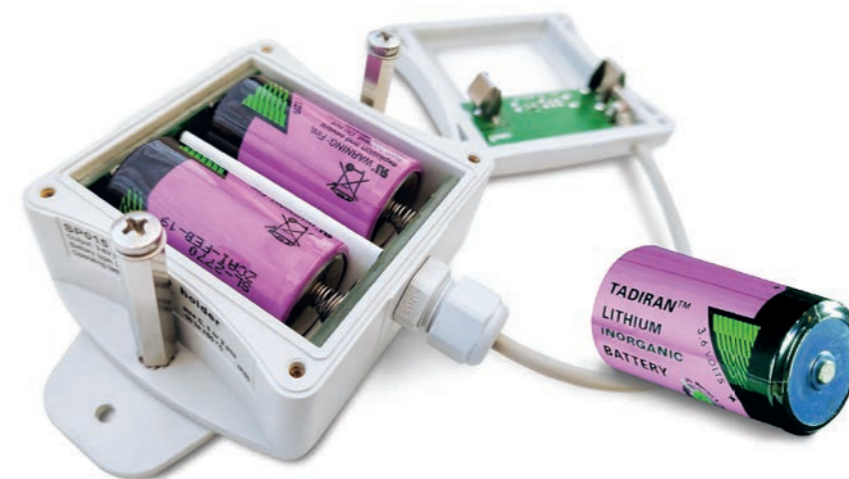

### Extension of operation time

The **SP015** Batteries holder is suitable for applications where the life of the transducer's internal battery is insufficient. Together with C size lithium battery it is extending up to six times the operating time compared to the standard life of size „AA“ internal battery.

**A4206**  
Replacement Lithium battery 3,6V, size C, for mounting in SP015 battery holder.





# IoT Sensor *plus*



**Temperature, relative humidity, atmospheric pressure and CO<sub>2</sub> concentration sensors with SIGFOX output**



Basic properties of the sensor SIGFOX *plus* are the same as those of the standard range of devices described in the previous page. The SIGFOX *plus* sensors measure every 1 minute (measurement of CO<sub>2</sub> concentration every 10 minutes), periodically send data in a configurable time interval to the COMET Cloud and signal critical situations for each measured quantity. In addition, they offer extreme battery life, CO<sub>2</sub> concentration measurement and temperature measurement in four places with one device. Some models can also be powered from an external power source (typically an AC adapter or an external high-capacity battery) - the internal battery then serves as a backup power source.

# IoT Sensor *plus* additionally offers

- Extra long battery life up to 10 years
- Measurement of CO<sub>2</sub> concentration up to 10.000 ppm
- Temperature monitoring of 4 places for one subscription fee
- Possibility of external powering for some models



Measuring of CO<sub>2</sub> for concentration up to 10.000 ppm with external probe (W8861).

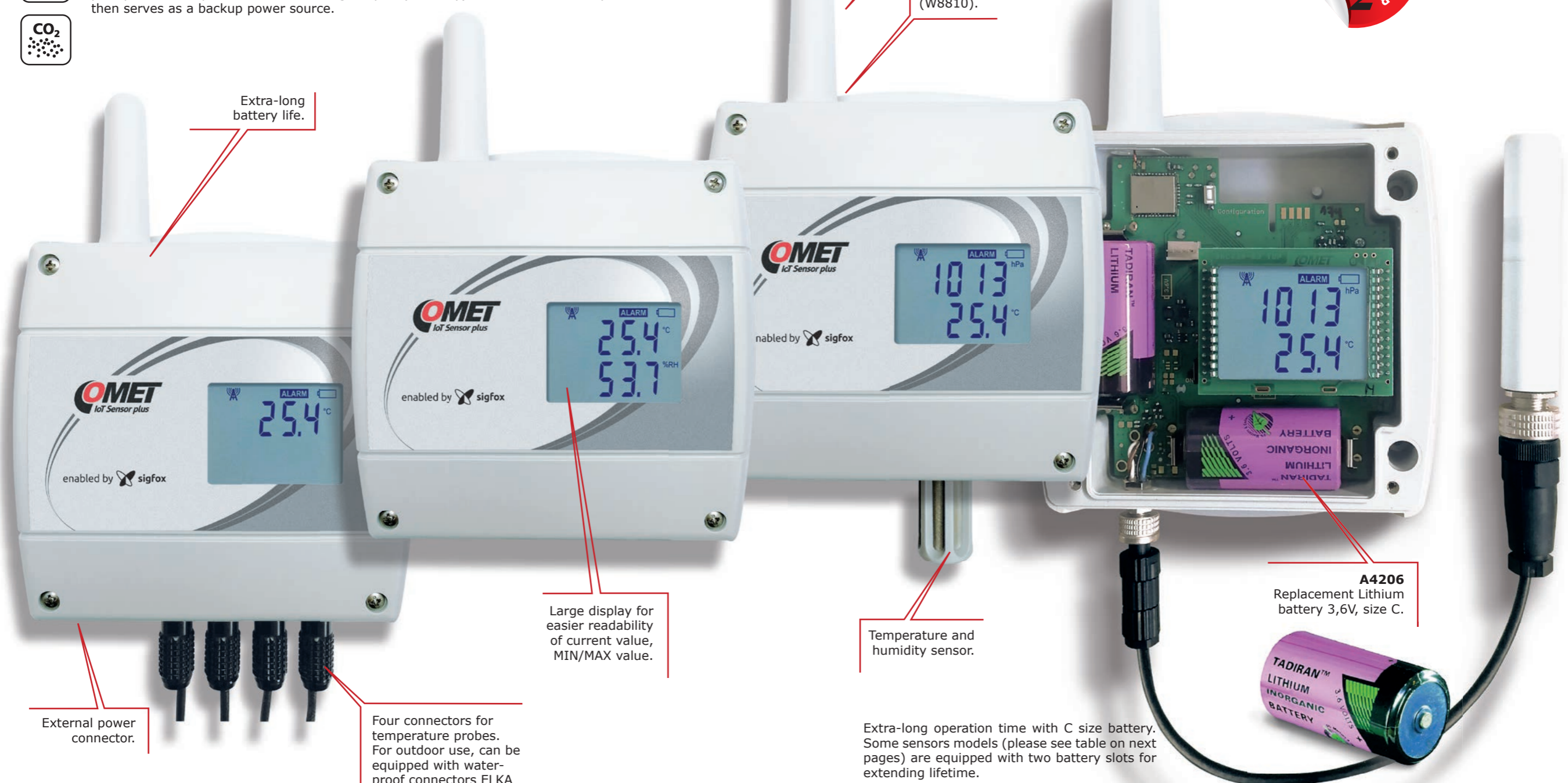

For more information visit [www.cometsystem.com](http://www.cometsystem.com)

Measured values		Temperature		Temperature relative humidity, CO <sub>2</sub>	Temperature, CO <sub>2</sub>	
SIGFOX SENSOR MODELS		W0841	W0841E	W6810	W8810	W8861
temperature	range	-90 to +260 °C	-90 to +260 °C	-20 to +60 °C	-20 to +60 °C	-20 to +60 °C
	accuracy	±0.2°C *	±0.2°C *	±0.4 °C	±0.4 °C	±0.4 °C
relative humidity	range			0 to 95 %RH		
	accuracy			±1.8% RH **		
dew point temperature measuring range ***				-60 to +60 °C		
CO <sub>2</sub>	range			0 to 5000 ppm		according to the probe
	accuracy			± (50 ppm + 3 % of measured value)		
barometric pressure	range					600 to 1100 hPa
	accuracy					±1.3 hPa
second battery slot		NO	NO	NO	YES	YES
external power supply connector		NO	YES	YES	YES	NO
class of protection of case with electronics / sensors		IP 65/ -	IP20 / -	IP20 / -	IP20 / -	IP 54/ IP65

\* accuracy of device w/o probe in measuring range of -90 to 100 °C (in range +100 to +260 °C is accuracy ±0,2 % of measured value) \*\* Accuracy of sensing element; from 0 to 90 %RH at 23 °C \*\*\* for accuracy of dew point see graphs at device manual

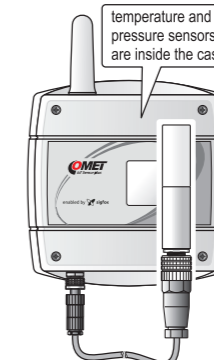
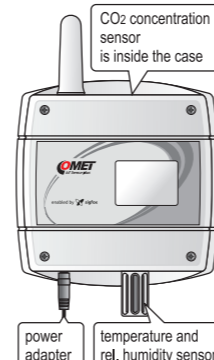
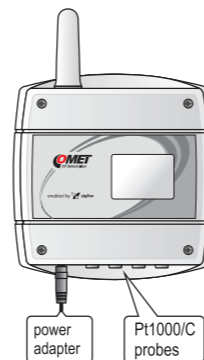
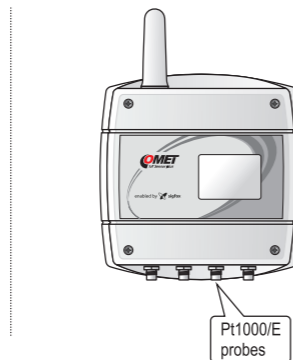
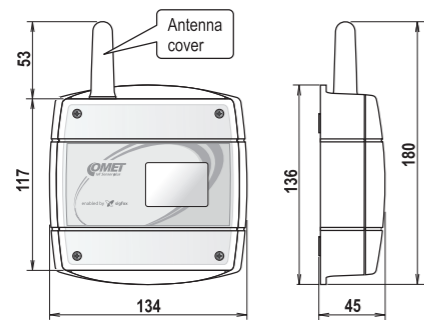

### External probe for W8861



SN220 - CO<sub>2</sub> external probe, range 0-10.000ppm

### External temperature probes

Temperature probes on the cable are designed to measure the temperature in specific applications. Probes are supplied in lengths of 1, 2, 5 and 10 meters. Probes are manufactured in accuracy of class A, unless stated otherwise.

Fast accurate air probe with fast response time without protection against moisture.

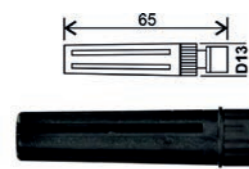

200-80/E, Pt1000 (-30°C to +80°C)

Universal temperature watertight probe with IP68 for long-term monitoring of temperature in liquids.

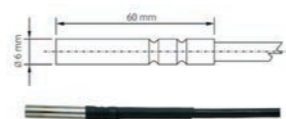

Pt1000TG68/E (-80°C to +200°C)

#### typical battery life

Sending interval	models 4x temperature (W0841, W0841E)	models with CO <sub>2</sub> measurement (W6810, W8810, W8861)	
	1 x battery	1 x battery	2 x batteries*
10 min	1 year	10 months	1.5 year
20 min	2 years	1 year	2 years
30 min	3 years	1.5 year	3 years
1 h	5 years	2 years	4 years
3 h	10 years	3 years	6 years
6 h	> 10 years	3.5 years	6.5 years
12 h	> 10 years	3.5 years	6.5 years
24 h	> 10 years	3.5 years	7 years

\* for models W8810 a W8861 only

The dual wavelength NDIR CO<sub>2</sub> sensing procedure compensates automatically for ageing effects.

The CO<sub>2</sub> module is highly resistant to pollution and offers maintenance free operation and outstanding long-term stability.

Extension cable of 1 meter (UWP01), 2 metres (UWP01-2) or 4 metres (UWP01-4) is available.

Hand-held pointed tip probe for food industry with teflon handle and silicon cable.

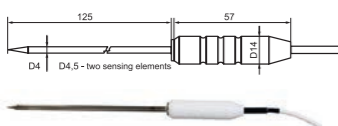

2061-200/E, Pt1000 (-30°C to +200°C)

The complete range of probes can be found at [www.cometsystem.com](http://www.cometsystem.com)

Brass probe for surface temperature measurements. Probe is not resistant to moisture.

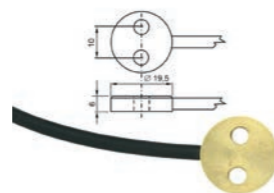

Pt1000TG7/E (-30°C to +200°C)

Inexpensive probe with plastic housing, slow response and with IP67.

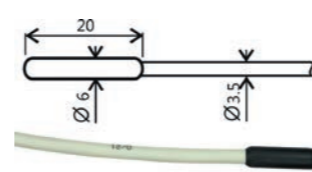

Pt1000TR160/E (-30°C to +80°C)

Strap-on probe for pipe mounting and flat surfaces. Class of protection - IP65.



PTS350A/E (-30°C to +130°C)

Multi-purpose watertight probe with IP67.

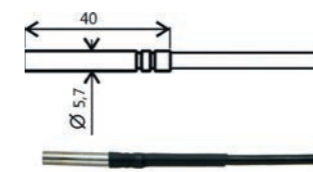

Pt1000TG8/E (-80°C to +200°C)



A1825 - External power supply for W0841E, W6810, W8810





# IoT Sensor *power*



**Temperature, relative humidity and voltage transmitters for the SIGFOX network**



SIGFOX power has the same basic features as those in the previous pages. In addition, they offer extreme battery life. The battery status information is in each sent message. The operation of the device is indicated by a multi-colored LED on its front cover. A low battery is also indicated. The Wx8xxP series transmitters are designed with increased resistance to external influences (especially water protection).

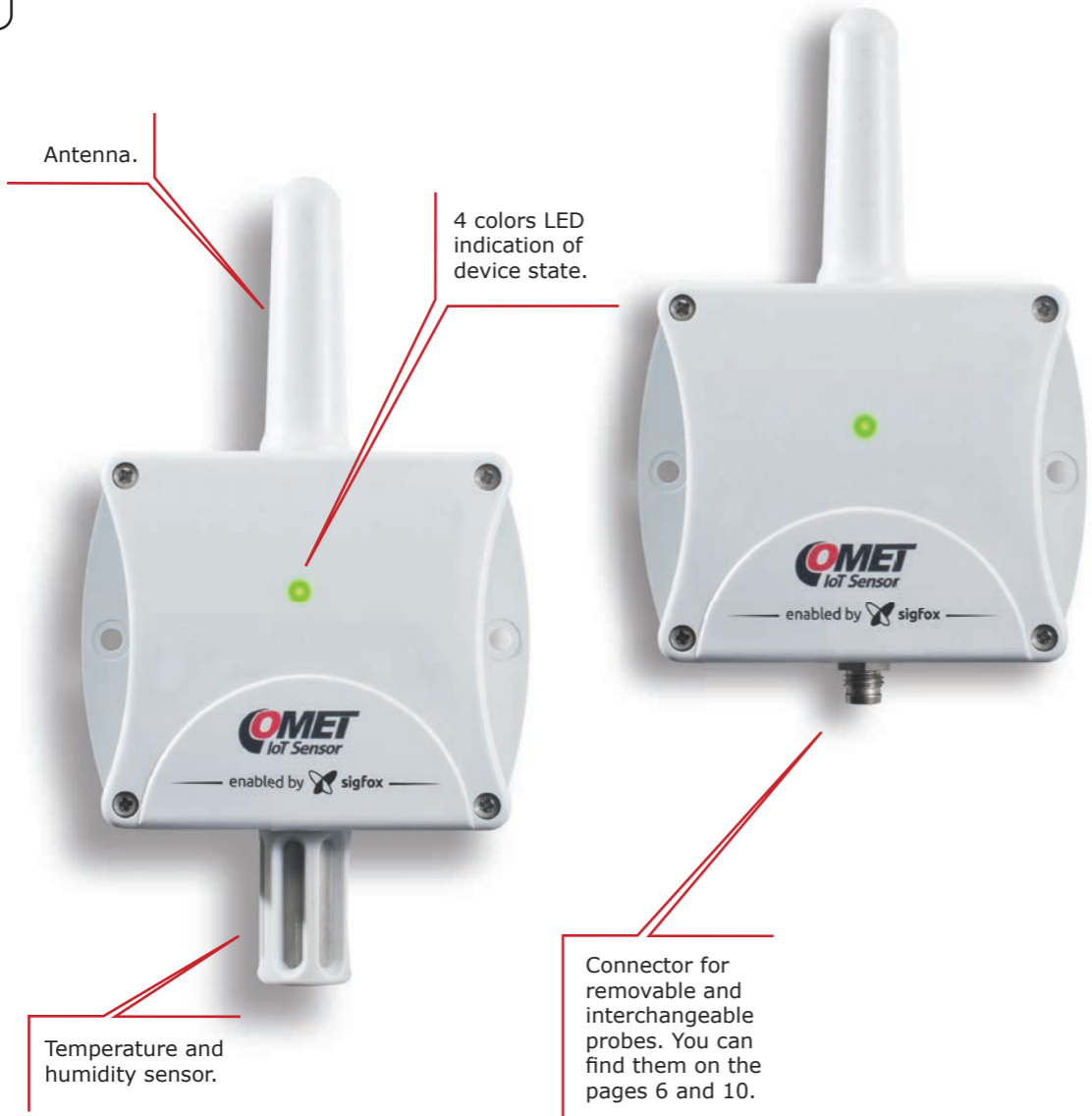

Temperature and humidity sensor.

# IoT Sensor *power* additionally offers

- Extra energy for triple longer operation time
- Compact design
- The voltage input for quantities from sensors with voltage output 0 to 30 V max

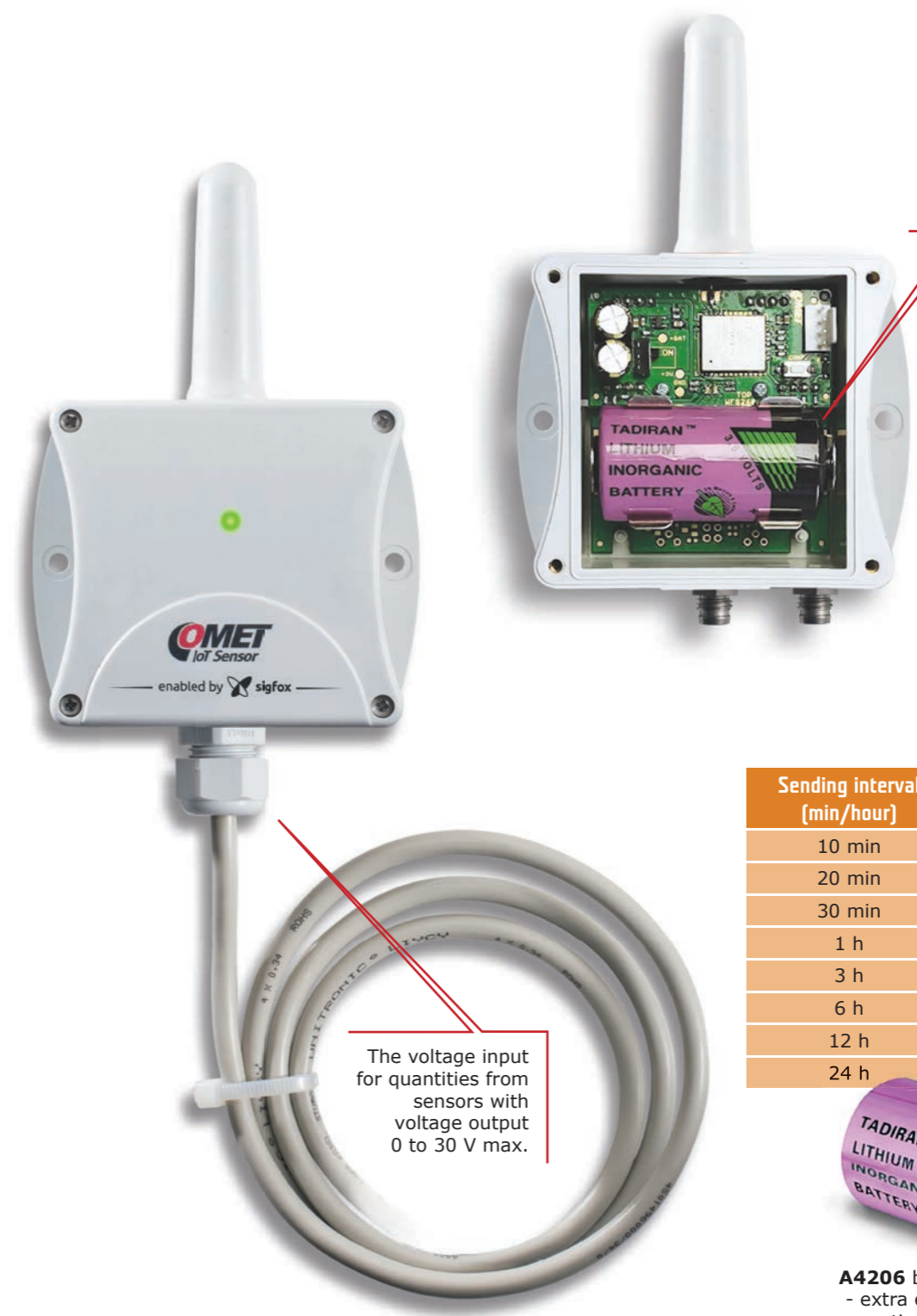

**A4206**  
Replacement  
Lithium  
battery 3,6V,  
size C.

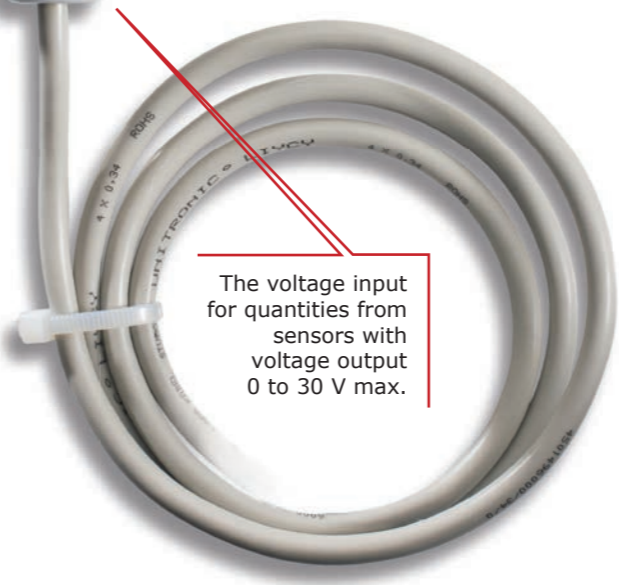

The voltage input for quantities from sensors with voltage output 0 to 30 V max.

Sending interval (min/hour)	1x lithium battery A4206 - 8500mAh
10 min	1 year
20 min	2 years
30 min	3 years
1 h	6 years
3 h	10 years
6 h	> 10 years
12 h	> 10 years
24 h	> 10 years



**A4206** battery - extra energy for triple longer operation time.

Measured values		temperature		voltage	temperature, relative humidity	
SIGFOX SENSOR MODELS		W0810P	W0832P	W0870P	W3810P	W3811P
tem- pera- ture	internal	range	-30 to +60 °C	-30 to +60 °C	-30 to +60 °C	-30 to +60 °C
		accuracy	±0.4 °C	±0.4 °C	±0.4 °C	±0.4 °C
	external	range	-	-90 to +260 °C	-	-
		accuracy	-	±0.2°C *	-	-
relative humidity**	range	-	-	-	0 to 100 % RH	-
	accuracy***	-	-	-	±1.8% RH **	±1.8% RH **
dew point	range****	-	-	-	-60 to +60 °C	according to the probe
voltage	range	-	-	-30 to +60 Vss	-	-
	accuracy	-	-	±0.03 V	-	-
class of protection of case with electronics / sensors		IP65	IP65	IP65	IP65 / IP40	

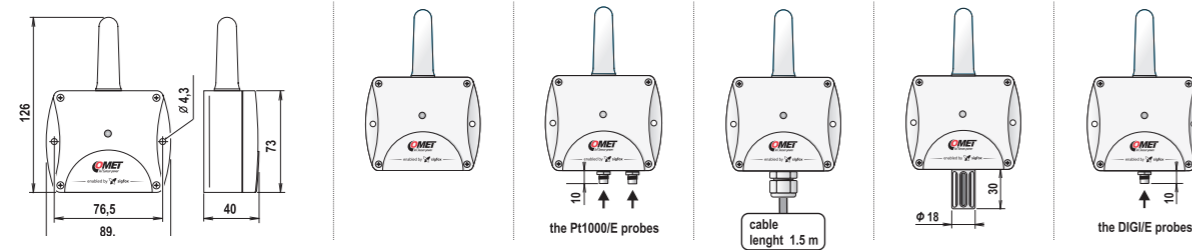

\* accuracy of device w/o probe in measuring range of -90 to 100 °C (in range +100 to +260 °C is accuracy ±0,2 % of measured value)  
 \*\* from 0 to 90 %RH at 23 °C  
 \*\*\* accuracy of sensing element  
 \*\*\*\* for accuracy of dew point see graphs at device manual

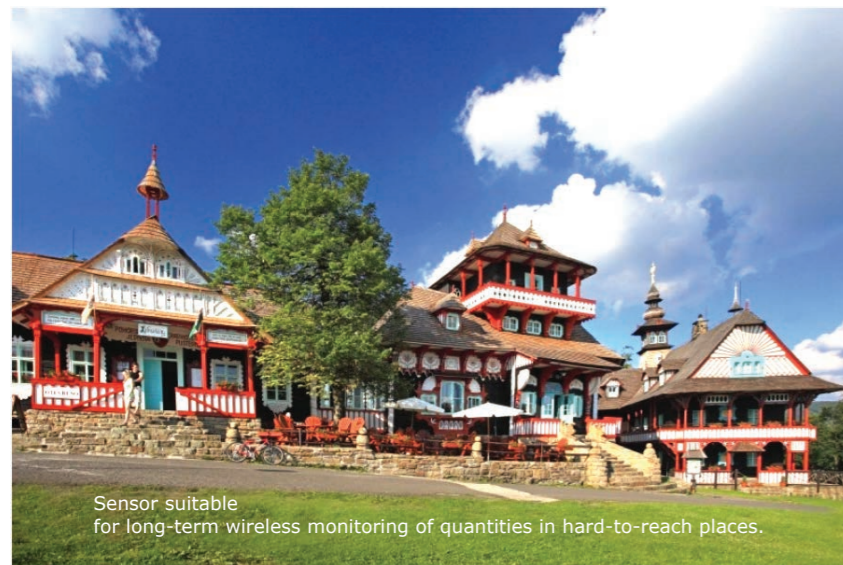

Sensor suitable for long-term wireless monitoring of quantities in hard-to-reach places.

The Libušín National Cultural Monument was opened to the public in 1899. In 2014, the building completely burned down. At present, the building has been rebuilt with elements of a combined extinguishing system based on the principle of inert gas (interior) and water mist (exterior). However, in order to use the extinguishing gas, a certain tightness of the building is necessary, which the Libušín log construction alone cannot ensure. For this reason, the insertion of foil between the log cabin and the wooden lining of the inner walls was designed. It was required to preventively monitor the relative humidity in an isolated area, where the measurement of temperature, relative humidity and dew point was installed at four selected points between the foil and the wooden interior paneling.



## Cometeo - professional solar shield

The Multi-plate radiation shield is used to protect weather monitor systems and provides the most accurate climate measurement results. The uniquely designed screen minimizes solar radiation reaching the sensor, minimizes radiation absorbed by the screen, and maximizes ambient airflow around the weather station sensor. The surface exposed to sunlight is made of highly reflective UV and long-term stable ASA plastic. The inner surfaces of the screen are made of matt black plastic to minimize internal reflections. A large 210mm diameter of 14 plates is designed to provide full protection for measuring sensor.

1.

Cometeo F8000 has a large diameter of lamels 210 mm and provides full protection of the measuring devices that can be located inside the cylindrical space with a diameter of 110 mm.

2.

F8001 - Universal naturally ventilated weather cover any measuring probes with a diameter of 133 to 18 mm before weather effects. As required a weather cover can be provided for another size mounting bushings for the probe.

3.

F8004 - version with four bushings  
**Version 2 and 3 can be used with most devices and probes, e.g. Vaisala, Rotronic.**



Operating temperature range -40 to +65 °C.

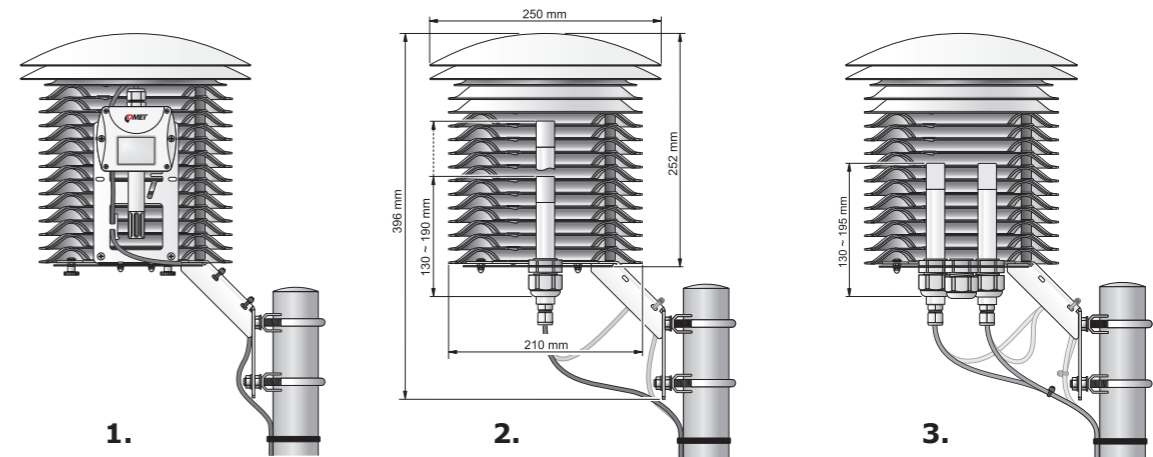



# IoT WIRELESS MEASURING INSTRUMENTS

Powered by Sigfox network



The COMET System, s.r.o. company is continuously developing and improving its product. COMET System, s.r.o. reserves the right to carry out technical changes in equipment or product without any previous notice.