

MyJ Sensores

# TEROS 10



METER™

[www.myj-sensores.com](http://www.myj-sensores.com) [info@myj-sensores.com](mailto:info@myj-sensores.com)

# TABLE OF CONTENTS

<b>1. Introduction</b> .....	1
<b>2. Operation</b> .....	2
2.1 Installation .....	2
2.2 Connecting.....	6
2.2.1 Connect to METER Data Logger.....	6
2.2.2 Connect to Non-METER Logger.....	7
2.3 Interfacing With Data Loggers.....	8
<b>3. System</b> .....	9
3.1 Specifications.....	9
3.2 Components .....	11
3.3 Theory.....	12
<b>4. Service</b> .....	13
4.1 Calibrations .....	13
4.1.1 Mineral Soils.....	13
4.1.2 Soilless Media.....	13
4.1.3 Apparent Dielectric Permittivity .....	14
4.2 Cleaning.....	14
4.3 Troubleshooting .....	15
4.4 Customer Support.....	16
4.5 Terms and Conditions .....	16
<b>Reference</b> .....	17
<b>Index</b> .....	18

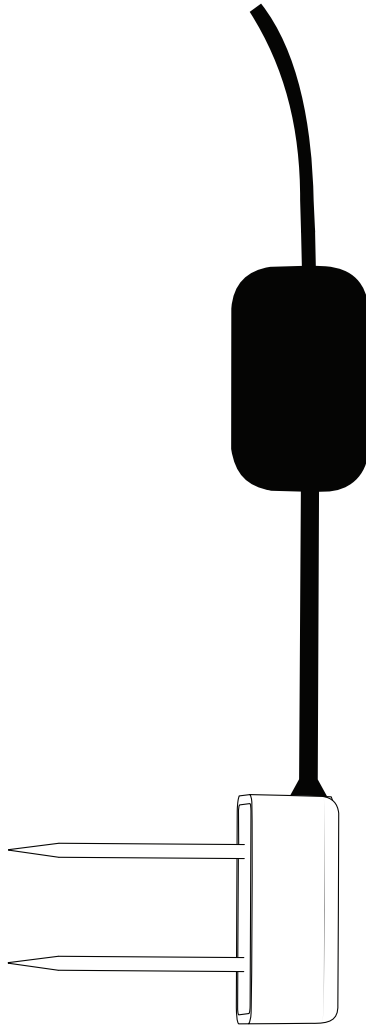

# 1. INTRODUCTION

Thank you for choosing the TEROS 10 Soil Moisture sensor.

The TEROS 10 sensor is designed to be installed in mineral soils, many types of growing media, and other porous materials.

This manual guides the customer through the sensor features and applications and describes how to use the sensor successfully. Common uses and measurements include:

- Volumetric water content (VWC) measurement
- Soil–water storage measurement
- Irrigation management

Prior to use, verify the TEROS 10 arrived in good condition. METER recommends testing the sensors with the data logging device and software before going to the field.

## 2. OPERATION

Please read all instructions before operating the TEROS 10 to ensure it performs to its full potential.

### ⚠ PRECAUTIONS

METER sensors are built to the highest standards. Misuse, improper protection, or improper installation may damage the sensor and possibly void the manufacturer's warranty. Before integrating the TEROS 10 into a system, follow the recommended installation instructions and have the proper protections in place to safeguard sensors from damage. If installing sensors in a lightning-prone area with a grounded data logger, see the application note [Lightning surge and grounding practices](#).

## 2.1 INSTALLATION

Follow the steps listed in [Table 1](#) to set up the TEROS 10 and start collecting data. For more detailed installation information consult the [TEROS soil moisture sensor installation best practices](#).

**Table 1 Installation**

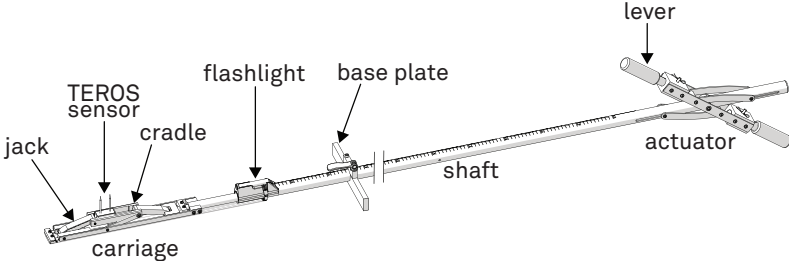
<p><b>Tools Needed</b></p>	<p>Auger or shovel</p> <p>Secure mounting location for data logger and cable</p> <p>Borehole Installation Tool (optional)</p> 
<p><b>Preparation</b></p>	<p><b>Determine Best Installation Method</b></p> <p>There are several methods for installing soil moisture sensors. These methods are described in <a href="#">Table 2</a>.</p>

**Table 1 Installation (continued)****Conduct System Check**

Plug the sensor into the data logger ([Section 2.2](#)) to make sure the sensor is functional.

Verify all sensors read within expected ranges. The TEROS verification clip gives the best assessment of proper sensor function and accuracy. The TEROS 10 should read 0.35 to 0.42  $\text{m}^3/\text{m}^3$  on the verification clip. If a verification clip is not available, test sensor functionality in air and water. The TEROS 10 will read  $\sim 0.64 \text{ m}^3/\text{m}^3$  in water (sensor head fully submerged to 1 cm up cable) and a slightly negative value in air.

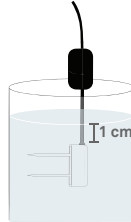
**Create Hole**

Avoid interfering objects.

- Installations near large metal objects can affect the sensor function and distort readings.
- Large objects like roots or rocks could potentially bend the needles.

Auger or trench a hole to the desired sensor installation depth and direction according to the installation method desired ([Table 2](#)).

**Insert Sensor**

Determine sensor orientation. The TEROS 10 sensor may be positioned in any direction. However, with the body in a vertical position (as shown below), there is less restriction to water flow. A vertical position will also integrate more soil depth into the soil moisture measurement. Installing the sensor with the body in a horizontal position will provide measurements at a more discreet depth. See [Measurement volume of METER volumetric water content sensors](#) for more information on sensor measurement volume.

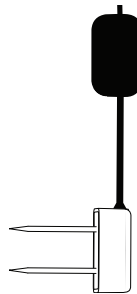

Sensor body vertical and needles horizontal

Installation

**Table 1 Installation (continued)**

Avoid having any metal located between the sensor and the ferrite core because it can interfere with VWC measurements.

**ATTENTION:** Minimize air gaps around the sensor. Air gaps around the sensor needles will result in low readings of soil moisture.

1. Load the TEROS 10 into the Borehole Installation Tool (BIT).

**NOTE:** The BIT provides a significant amount of mechanical advantage. See [Table 2](#) for instructions on installing the TEROS 10 without the BIT.

2. Lower the tool into the hole or trench with the back of the tool supported by the far wall.

**NOTE:** The Borehole Installation Tool does not work with the Downhole installation method.

3. Pull the tool lever to activate the jack and insert the sensor into the sidewall.

**WARNING:** When installing sensors in rocky soils, use care to avoid bending sensor needles.

#### Secure and Protect Cables

**NOTE:** Improperly protected cables can lead to severed cables or disconnected sensors. Cabling issues can be caused by many factors such as rodent damage, driving over sensor cables, tripping over cables, not leaving enough cable slack during installation, or poor sensor wiring connections.

Install cables in conduit or plastic cladding when near the ground to avoid rodent damage.

Gather and secure cables between the TEROS 10 and the data logger to the mounting mast in one or more places.

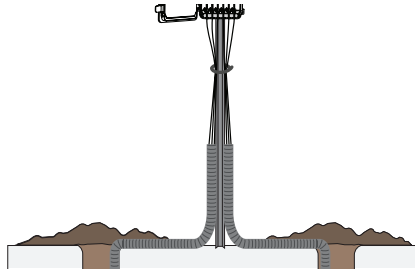

#### Connect to Data Logger

Plug the sensor into the data logger.

Use the data logger to make sure the sensor is reading properly.

Verify that these readings are within expected ranges.

For more instructions on connecting to data loggers, refer to [Section 2.2](#).

#### Backfill the Hole

Return soil to the hole, packing the soil back to its native bulk density.

Do not hit the ferrite core as this could potentially pull the sensor out of the soil.

Installation  
(continued)

Table 2 contains brief descriptions for typical installation methods. Each has its own advantages and disadvantages. For more information about which installation method is best for specific applications, please see the [TEROS soil moisture sensor installation best practices](#) or contact [Customer Support](#).

**Table 2 Installation methods**

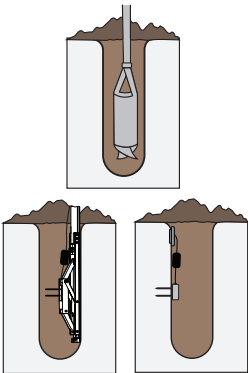
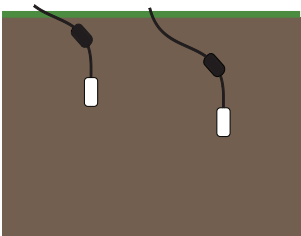
Borehole						
<p>This method uses the TEROS Borehole Installation Tool (Table 1) that allows a profile of soil moisture sensors to be installed at different depths within a single augered borehole. A 10-cm (4-in) borehole is augered vertically at the measurement location. The BIT is then used to install the sensors in the sidewall of the borehole.</p> <p><b>NOTE: The borehole method requires specialized installation tool available from METER if installing at depths greater than 50 cm.</b></p>		<table border="0"> <tr> <td data-bbox="789 324 936 458"><b>Advantage</b></td> <td data-bbox="961 324 1108 505"><b>Disadvantage</b></td> </tr> <tr> <td data-bbox="789 366 936 458">Minimizes soil disturbance at measurement site.</td> <td data-bbox="961 366 1108 505">Requires a specialized installation tool that can be rented from METER.</td> </tr> </table>	<b>Advantage</b>	<b>Disadvantage</b>	Minimizes soil disturbance at measurement site.	Requires a specialized installation tool that can be rented from METER.
<b>Advantage</b>	<b>Disadvantage</b>					
Minimizes soil disturbance at measurement site.	Requires a specialized installation tool that can be rented from METER.					
Trench						
<p>This method is best for shallow installations (less than 40 cm). This requires digging a trench with a shovel, excavator, etc. The trench needs to be dug to the depth of the deepest installed sensor. For deep installations, this may require a large trench.</p> <p>The sensor is installed carefully by hand into the undisturbed soil of the trench sidewall. The trench is carefully backfilled to preserve the bulk density of the soil and to avoid dislodging the installed sensor by accidentally snagging the ferrite core.</p>		<table border="0"> <tr> <td data-bbox="789 766 936 900"><b>Advantage</b></td> <td data-bbox="961 766 1108 1010"><b>Disadvantage</b></td> </tr> <tr> <td data-bbox="789 808 936 900">Does not require specialized equipment.</td> <td data-bbox="961 808 1108 1010">Large soil disturbance at measurement site.  Potentially large excavation effort.</td> </tr> </table>	<b>Advantage</b>	<b>Disadvantage</b>	Does not require specialized equipment.	Large soil disturbance at measurement site.  Potentially large excavation effort.
<b>Advantage</b>	<b>Disadvantage</b>					
Does not require specialized equipment.	Large soil disturbance at measurement site.  Potentially large excavation effort.					



## 2.2 CONNECTING

The TEROS 10 works seamlessly with METER data loggers. The TEROS 10 can also be used with other data loggers, such as those from Campbell Scientific, Inc. ([Section 2.2.2](#)).

TEROS 10 sensors require an excitation voltage in the range of 3.0 to 15.0 VDC and return an analog signal from 926 to 2500 mV.

TEROS 10 sensors come with a 3.5-mm stereo plug connector ([Figure 1](#)) to facilitate easy connection with METER loggers. TEROS 10 sensors may be ordered with stripped and tinned wires to facilitate connecting to some third-party loggers ([Section 2.2.2](#)).

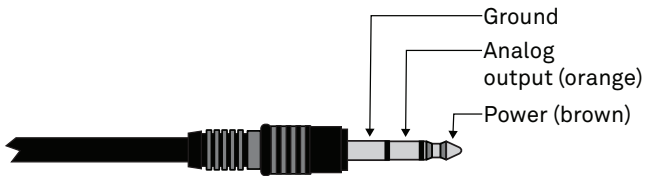

Figure 1 Stereo plug connector

The TEROS 10 sensor comes standard with a 5-m cable. It may be purchased with custom cable lengths up to a maximum of 40-m for an additional fee (on a per-meter basis).

### 2.2.1 CONNECT TO METER DATA LOGGER

The TEROS 10 sensor works most efficiently with METER ZENTRA series data loggers. Check the METER [download webpage](#) for the most recent data logger firmware. Logger configuration may be done using either ZENTRA Utility (desktop and mobile application) or ZENTRA Cloud (web-based application for cell-enabled data loggers).

1. Plug the stereo plug connector into one of the sensor ports on the logger.
2. Use the appropriate software application to configure the chosen logger port for the TEROS 10.

**NOTE:** The TEROS 10 is an analog sensor. The METER logger will not automatically identify the TEROS 10. Please use ZENTRA Utility or ZENTRA Cloud to apply the correct configuration.

3. Set the measurement interval.

METER data loggers measure the TEROS 10 every minute and return the average of the 1-min data across the chosen measurement interval.

TEROS 10 data can be downloaded from METER data loggers using either ZENTRA Utility or ZENTRA Cloud. Refer to the logger user manual for more information about these programs.

## 2.2.2 CONNECT TO NON-METER LOGGER

The TEROS 10 can be purchased for use with non-METER (third-party) data loggers. Refer to the third-party logger manual for details on logger communications, power supply, and ground ports. METER has some sample programs for third-party logger setup (see the METER [download webpage](#)).

TEROS 10 sensors can be ordered with stripped and tinned (pigtail) wires for use with screw terminals. Refer to the third-party logger manual for details on wiring.

Connect the TEROS 10 wires to the data logger as illustrated in [Figure 2](#) and [Figure 3](#), with the supply wire (brown) connected to the excitation, the analog out wire (orange) to an analog input, and the bare ground wire to ground.

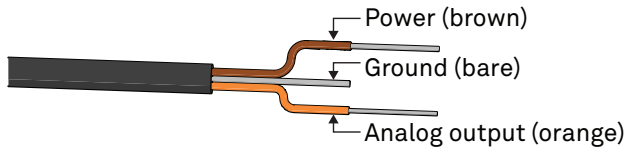

Figure 2 Pigtail wiring

**NOTE:** Some older adapter cables may have the older Decagon wiring scheme where the power supply is white, the digital out is red, and the bare wire is ground.

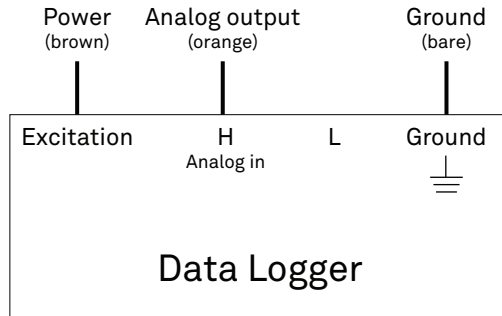

Figure 3 Wiring diagram

**NOTE:** The acceptable range of excitation voltages is from 3.0 to 15.0 VDC. To read TEROS 10 sensors with Campbell Scientific data loggers, power the sensors from a switched 12-V port.

If the TEROS 10 cable has a standard stereo plug connector and needs to be connected to a non-METER data logger, use one of the following two options.

### Option 1

1. Clip off the stereo plug connector on the sensor cable.
2. Strip and tin the wires.
3. Wire it directly into the data logger.

This option has the advantage of creating a direct connection and minimizes the chance of the sensor becoming unplugged. However, it then cannot be easily used in the future with a METER readout unit or data logger.

### Option 2

Obtain an adapter cable from METER.

The adapter cable has a connector for the stereo plug connector on one end and three wires (or pigtail adapter) for connection to a data logger on the other end. The stripped and tinned adapter cable wires have the same termination as in [Figure 3](#): the brown wire is excitation, the orange is output, and the bare wire is ground.

**NOTE:** Secure the stereo plug connector to the pigtail adapter connections using adhesive-lined heat shrink to ensure the sensor does not become disconnected during use.

## 2.3 INTERFACING WITH DATA LOGGERS

The TEROS 10 sensor is designed to work most efficiently with METER data loggers. All METER readout devices use a 3.0-VDC excitation.

The sensors, however, may be adapted for use with other data loggers, such as those from Campbell Scientific, Inc. The TEROS 10 requires an excitation voltage in the range of 3.0 to 15.0 VDC. The sensors produce an output voltage that depends on the dielectric constant of the medium surrounding the sensor, and ranges between 1,000 and 2,500 mV. Any data logger that can produce a 3.0- to 15.0-VDC excitation with approximately 10-ms duration and read a volt level signal with 12-bit or better resolution should be compatible with the TEROS 10 sensor. The current requirement for the TEROS 10 is 12 mA at 3 VDC.

METER designed the TEROS 10 sensor for use with data loggers and readout devices that provide short excitation pulses, leaving the sensors turned OFF most of the time. Continuous excitation not only wastes battery power, but may, under certain circumstances, cause the sensor to exceed government specified limits on electromagnetic emissions. Do not continuously power the TEROS 10 sensor.

### 3. SYSTEM

This section reviews the components and functionality of the TEROs 10 sensor.

#### 3.1 SPECIFICATIONS

##### MEASUREMENT SPECIFICATIONS

###### Volumetric Water Content (VWC)

###### Range

Mineral soil calibration	0.00–0.64 m <sup>3</sup> /m <sup>3</sup>
Soilless media calibration	0.0–0.7 m <sup>3</sup> /m <sup>3</sup>
Apparent dielectric permittivity ( $\epsilon_a$ )	1 (air) to 80 (water)

**NOTE:** The VWC range is dependent on the media the sensor is calibrated to. A custom calibration will accommodate the necessary ranges for most substrates.

Resolution	0.001 m <sup>3</sup> /m <sup>3</sup>
------------	--------------------------------------

###### Accuracy

Mineral soil calibration	±0.03 m <sup>3</sup> /m <sup>3</sup> typical in mineral soils that have solution EC <8 dS/m
Soilless media calibration	±0.05 m <sup>3</sup> /m <sup>3</sup> typical in media that has a solution EC <8 dS/m
Medium specific calibration	±0.01–0.02 m <sup>3</sup> /m <sup>3</sup> in any porous medium
Apparent dielectric permittivity ( $\epsilon_a$ )	1–40 (soil range) , ±1 $\epsilon_a$ (unitless) 40–80, 15% of measurement

###### Dielectric Measurement Frequency

70 MHz

##### COMMUNICATION SPECIFICATIONS

###### Output

1,000–2,500 mV

###### Data Logger Compatibility

Data acquisition systems capable of switched 3.0–15 VDC excitation and single-ended voltage measurement at greater than or equal to 12-bit resolution.

## PHYSICAL SPECIFICATIONS

### Dimensions

Length	5.1 cm (2.02 in)
Width	2.4 cm (0.95 in)
Height	7.5 cm (2.95 in)

### Needle Length

5.4 cm (2.11 in)

### Cable Length

5 m (standard)  
40 m (maximum custom cable length)

**NOTE:** Contact [Customer Support](#) if a nonstandard cable length is needed.

### Cable Diameter

$0.165 \pm 0.004$  ( $4.20 \pm 0.10$  mm) with minimum jacket of 0.030 (0.76 mm)

### Connector Types

Stereo plug connector or stripped and tinned wires

### Stereo Plug Connector Diameter

3.50 mm

### Conductor Gauge

22 AWG/24 AWG drain wire

## ELECTRICAL AND TIMING CHARACTERISTICS

### Supply Voltage (VIN to GND)

Minimum	3.0 VDC
Typical	NA
Maximum	15.0 VDC

### Operating Temperature Range

Minimum	-40 °C
Typical	NA
Maximum	60 °C

**NOTE:** Sensors may be used at higher temperatures under certain conditions; contact [Customer Support](#) for assistance.

Measurement Duration	
Minimum	10 ms
Typical	NA
Maximum	NA

## COMPLIANCE

EM ISO/IEC 17050:2010 (CE Mark)
2014/30/EU and 2011/65/EU
EN61326-1:2013 and EN55022/CISPR 22
EN 55011:2016/A1:2017 (GROUP 1, CLASS A-RCM mark)

## 3.2 COMPONENTS

The TEROS 10 sensor measures the volumetric water content of soil using stainless steel needles. A ferrite core positioned on the sensor cable 7.6 cm (3.0 in) away from the sensor head is utilized to isolate the sensor from any interferences in the system. This mitigates any potential noise from the system on the measured sensor data. It is important to not attach anything to the section of cable between the sensor head and the ferrite core as this may influence the measurements.

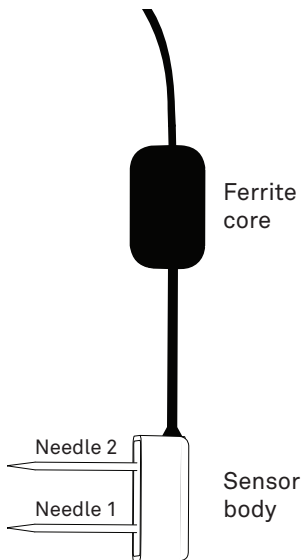

Figure 4 TEROS 10 sensor

The TEROS 10 VWC measurement sensitivity is contained within a 430-mL volume roughly depicted in Figure 5. Please see the application note [Measurement volume of METER volumetric water content sensors](#) for testing protocol and more thorough analysis.

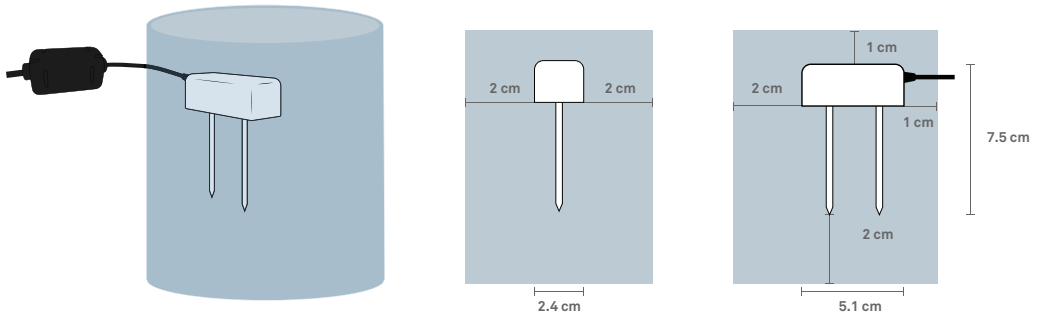

Figure 5 VWC volume of influence

NOTE: The TEROS 10 provides instantaneous or near-instantaneous measurements; however, because of the sensitivity of the measurement of the sensor head, the TEROS 10 is not well suited for spot measurements of VWC.

### 3.3 THEORY

The TEROS 10 sensors use an electromagnetic field to measure the apparent dielectric permittivity ( $\epsilon_a$ ) of the surrounding medium. The sensors supply a 70-MHz oscillating wave to the sensor needles, which charge according to the dielectric of the material. The charge time is proportional to substrate dielectric and substrate VWC. The microprocessor measures the charge time and outputs a raw value based on the substrate  $\epsilon_a$ . The raw value is then converted to VWC by a calibration equation specific to the substrate ([Section 4.1](#)).

## 4. SERVICE

This section contains information about calibration frequencies, cleaning guidelines, troubleshooting guidelines, customer support contact information, and terms and conditions.

### 4.1 CALIBRATIONS

Following are the explanations of the mineral soil, soilless media, and dielectric calibrations for Teros 10, where  $\theta$  is the VWC (in  $\text{m}^3/\text{m}^3$ ),  $\theta$  is dielectric, and RAW is the raw sensor output, when read with a METER or third-party data logger.

The Teros 10 is not sensitive to variation in soil texture and (electromagnetic conductivity) EC because it runs at a high measurement frequency. Therefore, its generic calibration equation should result in reasonable absolute accuracy:  $0.03 \text{ m}^3/\text{m}^3$  for most mineral soils up to 8 dS/m saturation extract. However, for added accuracy, customers are encouraged to perform [soil-specific calibrations](#).

#### 4.1.1 MINERAL SOILS

According to METER tests, a single calibration equation will generally suffice for most mineral soil types with ECs from 0 dS/m to 8 dS/m saturation extract. VWC ( $\theta$ ) is given by [Equation 1](#):

$$\theta\left(\text{m}^3 / \text{m}^3\right) = 1.895 \times 10^{-10} \times \text{RAW}^3 - 1.222 \times 10^{-6} \times \text{RAW}^2 + 2.855 \times 10^{-3} \times \text{RAW} - 2.154 \quad \text{Equation 1}$$

where RAW is the output from the METER data logger.

If using a non-METER data logger, VWC is given by [Equation 2](#):

$$\theta\left(\text{m}^3 / \text{m}^3\right) = 4.824 \times 10^{-10} \times \text{mV}^3 - 2.278 \times 10^{-6} \times \text{mV}^2 + 3.898 \times 10^{-3} \times \text{mV} - 2.154 \quad \text{Equation 2}$$

A third-order equation is used for the mineral soil calibration because it provides the best predictions of VWC in the range of VWC found in mineral soils, but this equation reaches a maximum at approximately  $0.77 \text{ m}^3/\text{m}^3$  in pure water according to [Equation 1](#). To display data on a scale from 0 to  $1.0 \text{ m}^3/\text{m}^3$ , VWC should be modeled with a quadratic equation (which would result in a  $1.0 \text{ m}^3/\text{m}^3$  in water). However, METER does not recommend this for mineral soils because it often makes the calibration in the range of VWC found in mineral soil less accurate.

#### 4.1.2 SOILLESS MEDIA

TEROS 10 sensors are calibrated in potting soil, perlite, and coir. The goal is to create a generic calibration equation that will work in many nonsoil substrates with an accuracy of  $0.05 \text{ m}^3/\text{m}^3$ . For higher accuracy, performing a media-specific calibration should improve the accuracy to 0.01 to  $0.02 \text{ m}^3/\text{m}^3$ . The differences between mineral soil and soilless media calibrations are caused by high air volume in the organic soils that lowers the starting (dry



media) dielectric of the sensor. For more information on how to calibrate sensors or to learn about METER calibration service (calibrations performed for a standard fee), review the article on [soil-specific calibrations](#) or contact [Customer Support](#).

The calibration for several potting soils, perlite, and peat moss is shown in [Equation 3](#):

$$\Theta(\text{m}^3 / \text{m}^3) = 2.137 \times 10^{-10} \times RAW^3 - 1.465 \times 10^{-6} \times RAW^2 + 3.566 \times 10^{-3} \times RAW - 2.683 \quad \text{Equation 3}$$

where RAW is the output from the METER data logger.

If using a non-METER data logger, VWC is given by [Equation 4](#):

$$\Theta(\text{m}^3 / \text{m}^3) = 5.439 \times 10^{-10} \times mV^3 - 2.731 \times 10^{-6} \times mV^2 + 4.868 \times 10^{-3} \times mV - 2.683 \quad \text{Equation 4}$$

### 4.1.3 APPARENT DIELECTRIC PERMITTIVITY

Apparent dielectric permittivity ( $\epsilon_a$ ) can be used to determine VWC using external published equations such as the Topp equation (Topp et al. 1980). Dielectric permittivity is also used for calculating pore water EC. Dielectric permittivity is given by [Equation 5](#):

$$\epsilon = 1.054 \times 10^{-1} \times e^{2.071 \times 10^{-3} \times RAW} \quad \text{Equation 5}$$

where RAW is the output from the METER data logger.

If using a non-METER data logger, VWC is given by [Equation 6](#):

$$\epsilon = 1.054 \times 10^{-1} \times e^{2.827 \times 10^{-3} \times mV} \quad \text{Equation 6}$$

## 4.2 CLEANING

If the sensor needles become contaminated with oils from contact with skin or another source, it is necessary to clean the needles to ensure accurate EC readings in salty soils with bulk EC greater than 10 dS/m.

1. Clean each needle using a mild detergent such as liquid dish soap and a nonabrasive sponge or cloth.

**NOTE:** Avoid detergents that contain lotions or moisturizers.

2. Rinse the sensor and needles thoroughly with tap or deionized (DI) water.

**NOTE:** Do not touch the needles with an ungloved hand or bring them in contact with any source of oil or other nonconducting residue.

## 4.3 TROUBLESHOOTING

**Table 3 Troubleshooting the TEROS 10**

Problem	Possible Solution
<b>Sensor not responding</b>	<p>Check power to the sensor.</p> <p>Check sensor cable and stereo plug connector integrity.</p> <p>Check data logger wiring to ensure brown is power supply, orange is analog out, and bare is ground.</p> <p>Try plugging into a different logger port.</p>
<b>Sensor reading too low (or slightly negative)</b>	<p>Check for air gaps around sensor needles. These could be produced below the surface of the substrate when the needle contacts a large piece of material and pushes it out of the way, or if the sensor is not inserted perfectly linearly.</p> <p>Ensure the calibration equation being used is appropriate for the media type. There are significant differences between substrate calibrations, so be sure to use the one specific to the substrate.</p> <p><b>NOTE: Sensor will read slightly negative in air when functioning properly.</b></p>
<b>Sensor reading too high</b>	<p>Check to make sure that the media was not packed excessively or insufficiently during sensor installation. Higher density can cause sensor reading to be elevated.</p> <p>Ensure the calibration equation being used is appropriate for the media type. There are significant differences between calibrations, so be sure to use the one most suitable to the substrate, or consider developing a substrate-specific calibration for the particular medium.</p> <p>Some substrates have an inherently high dielectric permittivity (soils of volcanic origin or high titanium, for instance). If the substrate has a dry dielectric permittivity above 6, a custom calibration may need to be performed. Soils with a bulk EC greater than 10 dS/m require substrate specific calibrations (<a href="#">Section 4.1</a>).</p>
<b>Cable or stereo plug connector failure</b>	<p>If a stereo plug connector is damaged or needs to be replaced contact <a href="#">Customer Support</a> for a replacement connector and splice kit.</p> <p>If a cable is damaged follow these <a href="#">guidelines for wire splicing and sealing techniques</a>.</p>

## 4.4 CUSTOMER SUPPORT

### NORTH AMERICA

Customer service representatives are available for questions, problems, or feedback Monday through Friday, 7:00 am to 5:00 pm Pacific time.

**Email:** [support.environment@metergroup.com](mailto:support.environment@metergroup.com)  
[sales.environment@metergroup.com](mailto:sales.environment@metergroup.com)

**Phone:** +1.509.332.5600

**Fax:** +1.509.332.5158

**Website:** [metergroup.com](http://metergroup.com)

### EUROPE

Customer service representatives are available for questions, problems, or feedback Monday through Friday, 8:00 to 17:00 Central European time.

**Email:** [support.europe@metergroup.com](mailto:support.europe@metergroup.com)  
[sales.europe@metergroup.com](mailto:sales.europe@metergroup.com)

**Phone:** +49 89 12 66 52 0

**Fax:** +49 89 12 66 52 20

**Website:** [metergroup.de](http://metergroup.de)

If contacting METER by email, please include the following information:

Name	Email address
Address	Instrument serial number
Phone	Description of the problem

**NOTE:** For products purchased through a distributor, please contact the distributor directly for assistance.

## 4.5 TERMS AND CONDITIONS

By using METER instruments and documentation, you agree to abide by the METER Group, Inc. Terms and Conditions. Please refer to [metergroup.com/terms-conditions](http://metergroup.com/terms-conditions) for details.

## REFERENCE

Topp, G. Clarke, J.L. Davis, and A. Peter Annan. 1980. "Electromagnetic Determination of Soil Water Content: Measurement in Coaxial Transmission Lines." *Water Resources Research* 16, no.3: 574–582.

# INDEX

- A**
  - applications 1
- C**
  - calibration 13–14
    - custom soils calibration 13
    - dielectric permittivity 14
    - mineral soils 13
    - soilless media 13
  - cleaning the sensors 14
  - compliance 11
    - CE mark 11
    - declaration of conformity 11
  - components 11–12
    - cable 10
    - connector types 10
    - ferrite core 11
    - needles 10, 11
  - configuration
    - See data logger
  - customer support 16
- D**
  - data loggers 6–7, 9
    - connect to METER logger 6
    - connect to non-METER logger 6–7
- E**
  - email address 16
- F**
  - fax number 16
  - ferrite core
    - about 11
- I**
  - installation
    - installation tool 2
    - methods 5–6
      - borehole 5
      - trench 5
    - preparation 2
    - tools needed 2
- P**
  - phone number 16
- R**
  - references 17
- S**
  - safety 2
  - specifications 9–12
    - data logger compatibility 9
    - dielectric measurement frequency 9
    - electrical and timing characteristics 10–12
    - physical specifications 10
    - volume of influence 12
    - volumetric water content 9
- T**
  - terms and conditions 16–17
  - troubleshooting 15–16
- V**
  - volumetric water content
    - specifications 9

**METER Group, Inc.**

2365 NE Hopkins Court Pullman, WA 99163  
T: +1.509.332.2756 F: +1.509.332.5158  
E: info@metergroup.com W: metergroup.com

**METER Group GmbH**

Mettlacher Straße 8, 81379 München  
T: +49 89 1266520 F: +49 89 12665220  
E: info.europe@metergroup.com W: metergroup.de

© 2018–2023 All Rights Reserved.

[www.myj-sensores.com](http://www.myj-sensores.com) [info@myj-sensores.com](mailto:info@myj-sensores.com)

