

# HOBO® Temp/RH 3.5% Data Logger (UX100-003) Manual



The HOBO Temp/RH data logger records temperature and relative humidity (within 3.5% accuracy) in indoor environments with its integrated sensors. Using HOBOWare®, you can easily configure the logger alarm to trip for specific high or low sensor readings. Or, you can set up burst logging in which the logger records data at a different interval during certain conditions. The logger can also calculate minimum, maximum, average, and standard deviation statistics. This compact data logger has a built-in LCD screen to monitor the current temperature, relative humidity, logging status, battery use, and memory consumption in between readouts.

## HOBO Temp/RH 3.5% Data Logger

UX100-003

### Included Items:

- Command™ strip
- Double-sided tape
- Hook & loop strap

### Required Items:

- HOBOWare 3.4 or later (download at [www.onsetcomp.com/hoboware-free-download](http://www.onsetcomp.com/hoboware-free-download))
- USB cable

## Specifications

### Temperature Sensor

Range	-20° to 70°C (-4° to 158°F)
Accuracy	±0.21°C from 0° to 50°C (±0.38°F from 32° to 122°F), see Plot A
Resolution	0.024°C at 25°C (0.04°F at 77°F), see Plot A
Response Time	4 minutes in air moving 1 m/s (2.2 mph)
Drift	<0.1°C (0.18°F) per year

### RH Sensor

Range	15% to 95% (non-condensing)
Accuracy	±3.5% from 25% to 85% including hysteresis at 25°C (77°F); below 25% and above 85% ±5% typical
Resolution	0.07% at 25°C (77°F) and 30% RH
Response Time	43 seconds to 90% in airflow of 1 m/s (2.2 mph)
Drift	<1% per year typical

### Logger

Logger Operating Range	Logging: -20° to 70°C (-4° to 158°F); 0 to 95% RH (non-condensing) Launch/Readout: 0° to 50°C (32° to 122°F) per USB specification
Logging Rate	1 second to 18 hours, 12 minutes, 15 seconds
Logging Modes	Fixed interval (normal), burst, or statistics
Memory Modes	Wrap when full or stop when full
Start Modes	Immediate, push button, date & time, or next interval
Stop Modes	When memory full, push button, or date & time
Restart Mode	Push button
Time Accuracy	±1 minute per month at 25°C (77°F), see Plot B
Power Source	One 3V CR2032 lithium battery and USB cable
Battery Life	1 year, typical with logging rate of 1 minute and sampling interval of 15 seconds or greater
Memory	128 KB (84,650 measurements, maximum)
Download Type	USB 2.0 interface
Full Memory Download Time	20 seconds
LCD	LCD is visible from 0° to 50°C (32° to 122°F); the LCD may react slowly or go blank in temperatures outside this range
Size	3.66 x 8.48 x 1.52 cm (1.44 x 3.34 x 0.6 in.)
Weight	30 g (1.06 oz)
Environmental Rating	IP50
	The CE Marking identifies this product as complying with all relevant directives in the European Union (EU).

Specifications (continued)

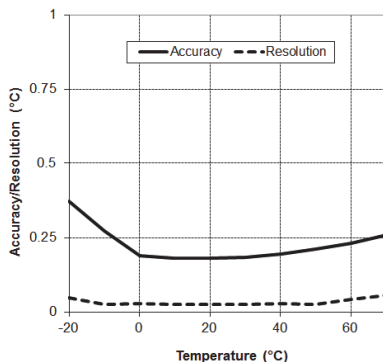

Plot A: Temperature Accuracy and Resolution

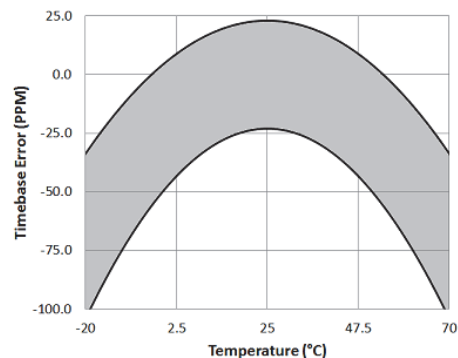

Plot B: Time Accuracy

Logger Components and Operation

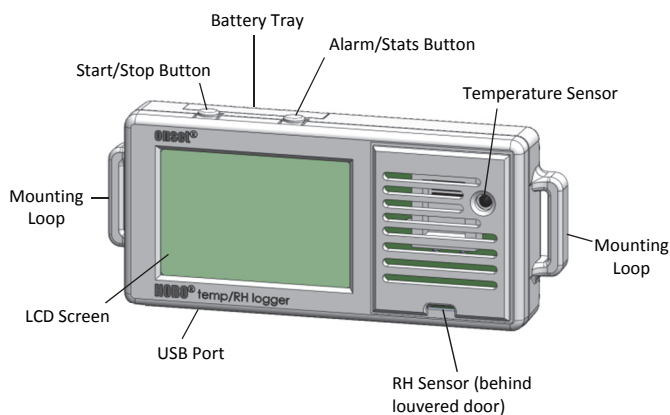

**LCD Screen:** This logger is equipped with an LCD screen that displays details about the current status. This example shows all symbols illuminated on the LCD screen followed by definitions of each symbol in the table below.

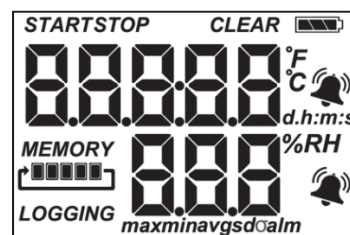

**Start/Stop Button:** Press this button for 3 seconds to start or stop logging data, or to resume logging on the next even logging interval. This requires configuring the logger in HOBOWare with a push button start or stop, and with “Resume logging on next button push” selected (see *Setting up the Logger*). You can also press this button for 1 second to record an internal event (see *Recording Internal Logger Events*) or to turn the LCD screen on if the option to turn off the LCD has been enabled (see *Setting up the Logger*).

**Battery Tray:** Remove the battery tray on the top of the logger to access the logger battery (see *Battery Information*).

**Alarm/Stats Button:** Use this button to clear a tripped alarm (see *Setting up Alarms*) or to switch between statistics, alarm readings, and the current sensor readings.

**Mounting Loops:** Use the two mounting loops to mount the logger with the hook-and-loop strap (see *Mounting the Logger*).

**Temperature Sensor:** This sensor is located at the far right side of the logger, slightly behind the louvered door in the logger case.

**RH Sensor:** This sensor is located behind the louvered door in the logger case to the right of the LCD screen.

**USB Port:** Use this port (not visible in the diagram) to connect the logger to the computer or the HOBO U-Shuttle via USB cable (see *Setting up the Logger and Reading Out the Logger*).

LCD Symbol	Description
<b>START</b>	The logger is waiting to be launched. Press and hold the Start/Stop button for 3 seconds to launch the logger.
<b>STOP</b>	The logger has been launched with a push button stop enabled; press and hold the Start/Stop button for 3 seconds to stop the logger. <b>Note:</b> If you also launched the logger with a push button start, this symbol will not appear on the display for 30 seconds.
	The battery indicator shows the approximate battery power remaining.
<b>MEMORY</b> 	The logger has been configured to stop logging when memory fills. The memory bar indicates the approximate space remaining in the logger to record data. When first launched, all five segments in the bar will be empty. In this example, the logger memory is almost full (only one segment in the memory bar is empty).
<b>MEMORY</b> 	The logger has been configured to never stop logging (wrapping). The logger will continue recording data indefinitely, with newest data overwriting the oldest data. When first launched, all five segments in the memory bar will be empty. In this example, the memory is full (all five segments are filled in) and new data is now overwriting the oldest data. This will continue until the logger is stopped or the battery runs out.

LCD Symbol	Description
<b>LOGGING</b>	The logger is currently logging.
	A sensor reading is above or below the high or low alarm that you configured. Press and release the Alarm/Stats button until the “alm” symbol (described below) is displayed on the screen. This symbol at left will clear depending on how alarms were configured in HOBOWare. If the alarm was configured to clear when the logger is relaunched, this symbol will remain on the LCD. Otherwise, it will clear when the sensor reading is back within the alarm limits or by pressing the Alarm/Stats button for 3 seconds.
<b>CLEAR</b>	An alarm is ready to be cleared. This will only appear if “Cleared with button press” was selected in the HOBOWare alarm settings. Press the Alarm/Stats button for 3 seconds to clear the alarm.
<b>max min avg sdσ</b>	These symbols show the maximum, minimum, average, and standard deviation values most recently calculated for the logger (if the logging mode has been set to Statistics in HOBOWare). Press the Alarm/Stats button for 1 second to cycle through each of the available statistics and then back to the current sensor reading (or to the alarm value if applicable).
<b>alm</b>	This is the sensor reading that tripped the alarm. Press the Alarm/Stats button to view this reading. Press the Alarm/Stats button again to cycle through any statistics (defined above) and ultimately back to the current sensor reading.
<b>80.2°F</b>	This is an example of a temperature reading. Temperature units are determined by the settings in HOBOWare. To switch between Celsius and Fahrenheit, change the Display Preferences in HOBOWare before launching the logger.
<b>68.0%RH</b>	This is an example of an RH reading.
<b>05:38 m:s</b>	The logger has been configured to start logging on a particular date/time. The display will count down in days, hours, minutes, and seconds until logging begins. In this example, 5 minutes and 38 seconds remain until logging will begin.
<b>LoAd</b>	The launch settings are being loaded onto the logger from HOBOWare. Do not disconnect the USB cable during this process.
<b>Err</b>	An error occurred while loading the launch configurations onto the logger from HOBOWare. Make sure the USB cable is connected to both the logger and the computer and try launching again.
<b>StoP</b>	The logger has been stopped with HOBOWare or because the memory is full.

**Notes:**

- You can disable the LCD screen when logging. Select “Turn LCD off” when setting up the logger as described in the next section. When this option is enabled, you can still temporarily view the LCD screen by pushing the Start/Stop button for 1 second. The LCD will then remain on for 10 minutes.
- The LCD screen refreshes every 15 seconds regardless of the logging interval selected in HOBOWare. If you choose a logging interval less than 15 seconds, the data will be recorded at the faster interval, but the sensor readings will only be updated on the screen every 15 seconds.

- When the logger has stopped logging, the LCD screen will remain on until the logger is offloaded to a computer or HOBO U-Shuttle (unless launched with the “Turn LCD off” option). Once the logger has been offloaded and disconnected from the computer, the LCD will turn off automatically after 2 hours. The LCD will turn back on the next time the logger is connected to the computer.

**Setting up the Logger**

Use HOBOWare to set up the logger, including setting alarms, selecting the options to start and stop logging, and choosing a logging mode.

**1. Connect the logger and open the Launch Logger window.**

To connect the logger to a computer, use the USB cable provided. Click the Launch icon on the HOBOWare toolbar or select Launch from the Device menu.

**Important:** USB 2.0 specifications do not guarantee operation outside the range of 0°C (32°F) to 50°C (122°F).

- Select the sensors to log in this deployment.** Choose Temperature or Temperature and RH. Type a label for the sensor(s) if desired. Note that both sensors are required to calculate dew point, which is an additional data series available for plotting after reading out the logger.

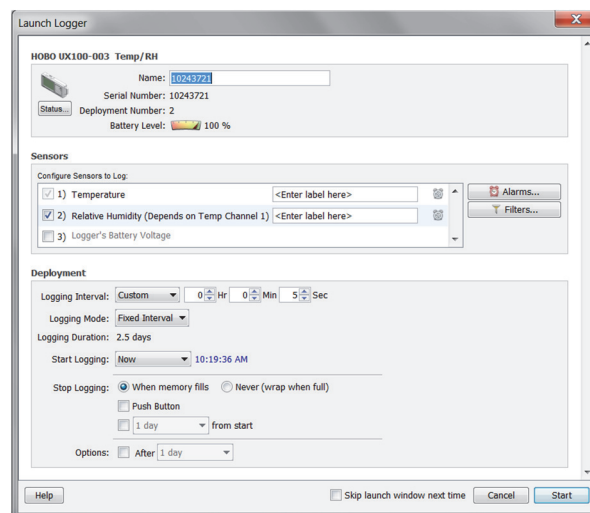

- Set up alarms (optional).** Click the Alarms button if you want to configure an alarm to trip when the sensor reading is above or below a value you specify. See *Setting up Alarms* for details.
- Configure filters (optional).** Click the Filters button to create additional filtered data series. Any filtered series will be available automatically upon reading out the logger.
- Select the Logging Interval.** Select a logging interval from 1 second to a maximum of 18 hours, 12 minutes, and 15 seconds.
- Select the Logging Mode:**
  - Fixed Interval.** In Fixed Interval mode, data will always be recorded at the regular logging interval set in the previous step. This is the default setting.
  - Burst.** In Burst mode, logging will occur at a different interval when a specified condition is met. See *Burst Logging* for more information.

- **Statistics.** In Statistics mode, maximum, minimum, average, and standard deviation statistics are calculated for all enabled sensors during logging, sampling at an interval you specify. See *Statistics* for more information.

#### 7. Choose when to start logging:

- **Now.** Logging begins immediately.
- **At Interval.** Logging will begin at the next even interval as determined by the selected logging interval.
- **On Date/Time.** Logging will begin at a date and time you specify.
- **Push Button.** Logging will begin once you press the Start/Stop logging button for 3 seconds.

#### 8. Choose when to stop logging:

- **When Memory Fills.** Logging will end once the logger memory is full.
- **Never (Wrap When Full).** The logger will continue recording data indefinitely, with newest data overwriting the oldest. This option is not available if Burst is selected for the Logging Mode.
- **Push Button.** Logging will end once you press the Start/Stop logging button for 3 seconds. Note that if you also choose Push Button to start logging, then you will not be able to stop logging until 30 seconds after logging begins.

If you select the Push Button setting, then you also have the option to select “Allow button restart.” This allows you to stop and then restart logging during the deployment by pushing the Start/Stop button on the logger for 3 seconds.

**Important:** When “Allow button restart” is selected and you use the Start/Stop button to stop and restart logging, logging will restart on the next even logging interval, not at the time the button was pushed. For example, a logger started logging at 7:00 AM with a logging interval set to 1 hour. If you press the Start/Stop button to stop the logger at 8:45 AM and then press the button again at 10:15 AM, logging will not begin immediately at 10:15. Instead, logging will begin again at 11:00 AM, which is the next even interval time based on your 1-hour logging interval. Therefore, depending on the logging interval, the gap between the time you press the button to resume logging and the time actual logging begins could be significant. The faster the logging interval, the less time will elapse before logging resumes.

- **Specific Stop Date.** Logging will end at a date and time you specify. Note that if you also configure the logger for a Push Button stop and to “Allow button restart,” then the logger will stop logging at the date you select regardless of how many times you stop and restart the logger with the Start/Stop button.
9. **Choose whether to keep the LCD on or off.** By default, the LCD will always remain on while logging. If you select the “Turn LCD off” checkbox, the LCD will not show the current readings, status, or other information while the logger is logging. You will, however, be able to temporarily turn the LCD screen on by pressing the Start/Stop button for 1 second if you select this option.

10. **Click the Start button to launch the logger.** Disconnect the logger from the computer and deploy it using the mounting materials (see *Mounting the Logger*). After logging begins, you can read out the logger at any time (see *Reading Out the Logger* for details).

## Setting up Alarms

You can set an alarm to trip on the logger when a sensor reading rises above or falls below a specified value. To set an alarm:

1. Click the Alarms button from the Launch Logger window. If the Alarms button is disabled, make sure the Logging Mode is not set to Burst. (Alarms can only be configured if the logger is in Normal or Statistics mode.)
2. Select a sensor. In this example, the temperature sensor was selected.

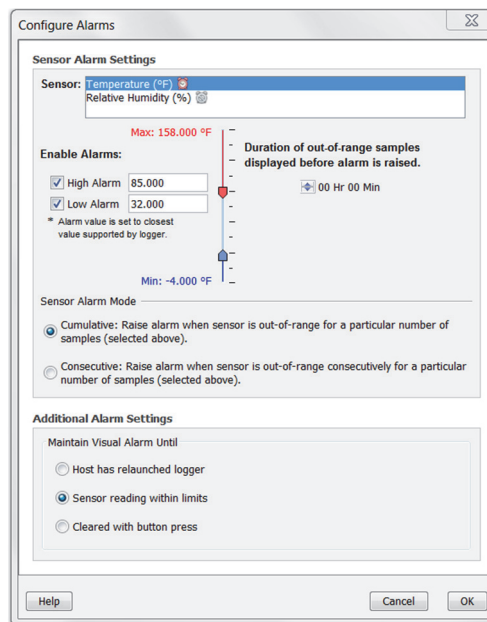

3. Select the High Alarm checkbox if you want an alarm to trip when the sensor reading rises above the high alarm value. Type the reading next to the High Alarm checkbox or drag the red upper slider in the Configure Alarms window.
4. Select the Low Alarm checkbox if you want an alarm to trip when the sensor reading falls below the low alarm value. Type the reading next to the Low Alarm checkbox or drag the blue lower slider.
5. Set the duration before an alarm is tripped.
6. Select either Cumulative or Consecutive. If you select Cumulative, then the alarm will trip when the time the sensor is out of range over the course of the deployment is equal to the selected duration. If you select Consecutive, then the alarm will trip when the time the sensor is continuously out of range is equal to the selected duration. For example, the high alarm for temperature is set to 85°F and the duration is set to 30 minutes. If Cumulative is selected, then an alarm will trip once a sensor reading has been at or above 85°F for a total of 30 minutes since the logger was configured; specifically, this could be 15 minutes above 85°F in the morning and then 15 minutes above 85°F again in the afternoon. If Consecutive is selected, then an

alarm will trip only if all sensor readings are 85°F or above for a continuous 30-minute period.

7. Repeat steps 2 through 6 for the other sensor if desired.
8. Choose how long the logger should maintain a sensor alarm once it has tripped. Select “Host has relaunched logger” if you want the alarm to remain visible on the LCD until the next time you relaunch the logger. Select “Sensor reading within limits” if you want the alarm to clear once the sensor reading returns to the normal range between the high and low alarm limits. Select “Cleared with button press” if you want the alarm to remain on until you press the Alarm/Stats button on the logger.
9. Click OK to save alarm settings.

#### Notes:

- Once the logger is launched, alarms will trip as determined by these settings. Logger alarms will display on the LCD screen. Note that the alarm limits are only checked when the logger’s LCD screen refreshes every 15 seconds.
- The actual values for the high and low alarm limits are set to the closest value supported by the logger. For example, the closest value to 85°F that the UX100 series logger can record is 84.990°F and the closest value to 32°F is 32.043°F. In addition, alarms can trip or clear when the sensor reading is within the logger specifications of 0.02°C resolution. This means the value that triggers the alarm may differ slightly than the value entered. For example, if the High Alarm is set to 75.999°F, the alarm can trip when the sensor reading is 75.994°F (which is within the 0.02°C resolution).
- When you read out the logger, high and low alarm levels will be displayed on the plot along with “Chan <#> Alarm Tripped” and “Chan <#> Alarm Cleared” events showing when the sensor alarm tripped and cleared. The “Chan <#> Alarm Cleared” event contains the value that was furthest out of range for the sensor before the alarm cleared (see the Points table for the actual value).

## Burst Logging

Burst logging is a logging mode that allows you to set up more frequent logging when a specified condition is met. For example, let’s say the logger is recording data at a 5-minute logging interval and burst logging is configured to log every 10 seconds when the temperature goes above 85°F (the high limit) or falls below 32°F (the low limit). This means the logger will record data every 5 minutes as long as the temperature remains between 85°F and 32°F. Once the temperature reaches 90°F, for example, the logger will switch to the faster logging rate and record data every 10 seconds until the temperature falls back below the high limit (or 85°F in this case). At that time, logging then resumes every 5 minutes at the normal logging interval. Similarly, if the temperature falls to 30°F, for example, then the logger would switch to burst logging mode again and record data every 10 seconds. Once the temperature rises back to 32°F, the logger will then return to normal mode, logging every 5 minutes.

To set up burst logging:

1. Select Burst for Logging Mode in the Launch Logger window. If Burst has already been configured for this logger, click the Edit button in the Launch Logger window.

Note that you cannot set up alarms with burst logging. You also cannot select the Stop Logging option “Never (wrap when full)” if burst logging is configured.

2. In the Burst Logging window, select a sensor. In the example, the temperature sensor was selected.
3. Select the High Limit checkbox if you want to set up a condition in which burst logging will occur when the sensor reading rises above the high limit value. Type in the value or drag the red upper slider.
4. Select the Low Limit checkbox if you want to set up a condition in which burst logging will occur when the sensor reading falls below the low limit value. Type in the value or drag the blue lower slider.

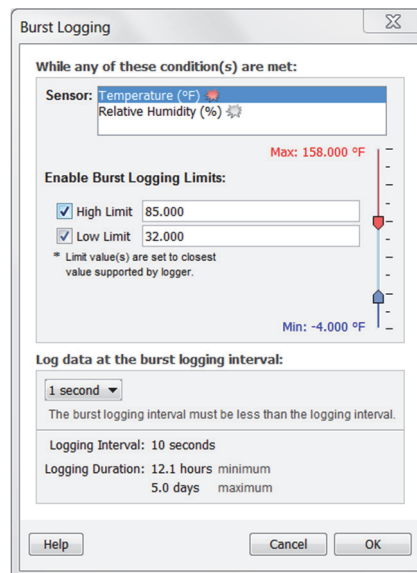

5. Repeat steps 2 through 4 for the other sensor, if desired.
6. Set the burst logging interval, which must be less than the logging interval. Select either a preset burst logging interval or select Custom and enter your own interval. Keep in mind that the more frequent the burst logging rate, the greater the impact on battery life and the shorter the logging duration.
7. Click OK when done. This will return you to the Launch Logger window. Click the Edit button next to Logging Mode in the Launch Logger window to make additional changes.

#### Notes:

- Once the logger is launched, the high and low burst logging limits are only checked when the logger’s LCD screen refreshes once every 15 seconds. Therefore, if you set the logging interval to less than 15 seconds and the sensor reading falls outside the limits, the burst logging will not begin until the next 15-second refresh cycle.
- If high and/or low limits have been configured for more than one sensor, then burst logging will begin when any high or low condition goes out of range. Burst logging will not end until all conditions on all sensors are back within normal range.
- The actual values for the burst logging limits are set to the closest value supported by the logger. For example, the closest value to 85°F that the logger can record is 84.990°F and the closest value to 32°F is 32.043°F.

- Burst logging mode can begin or end when the sensor reading is within the logger specifications of 0.02°C resolution. This means the value that triggers burst logging may differ slightly than the value entered. For example, if the high limit for a temperature alarm is set to 75.999°F, burst logging can start when the sensor reading is 75.994°F (which is within the 0.02°C resolution).
- Once the high or low condition clears, the logging interval time will be calculated using the last recorded data point in burst logging mode, not the last data point recorded in “normal mode.” For example, let’s assume the logger has a 10-minute logging interval and logged a data point at 9:05. Then, the high limit was surpassed and burst logging began at 9:06. Burst logging then continued until 9:12 when the sensor reading fell back below the high limit. Now back in normal mode, the next logging interval will be 10 minutes from the last burst logging point, or 9:22 in this case. If burst logging had not occurred, the next data point would have been at 9:15.
- A New Interval event will appear on the plot (if you select events for plotting in the Plot Setup window) each time the logger enters or exits burst logging mode.

## Statistics

Statistics is a logging mode in which the logger calculates maximum, minimum, average, and standard deviation statistics during logging, recording the results at each logging interval based on samples taken at a rate you specify. This will result in up to four additional series per sensor that record the following information at each logging interval:

- The maximum, or highest, sampled value,
- The minimum, or lowest, sampled value,
- An average of all sampled values, and
- The standard deviation from the average for all sampled values.

For example, let’s say both the temperature and RH sensors have been enabled, the logging interval is set to 5 minutes and the sampling interval is set to 30 seconds (with maximum, minimum, average, and standard deviation all enabled). Once logging begins, the logger will measure and record the actual temperature and RH sensor values every 5 minutes. In addition, the logger will take a temperature and RH sample every 30 seconds and temporarily store them in memory. The logger will then calculate the maximum, minimum, average, and standard deviation using the samples gathered over the previous 5-minute period and log the resulting values. When reading out the logger, this would result in 10 data series (not including any derived series, such as dew point): two sensor series (with temperature and RH data logged every 5 minutes) plus eight maximum, minimum, average, and standard deviation series (four for temperature and four for RH with values calculated and logged every 5 minutes based on the 30-second sampling).

To set up statistics:

1. Select Statistics for Logging Mode in the Launch Logger window. If Statistics has already been configured for this logger, click the Edit button in the Launch Logger window.
2. Click the Maximum, Minimum, Average, and Standard Deviation checkboxes for each of the statistics you want to calculate during logging. Note that Average is automatically enabled when selecting Standard Deviation. **Important:** Statistics apply to all enabled sensors; every selected statistic will be calculated for all sensors (except battery voltage). For example, if both the temperature and RH sensors have been selected in the Launch Logger window and you select Average, then the average will be calculated for both temperature and RH. In addition, the more statistics you record, the shorter the logger duration and the more memory is required.

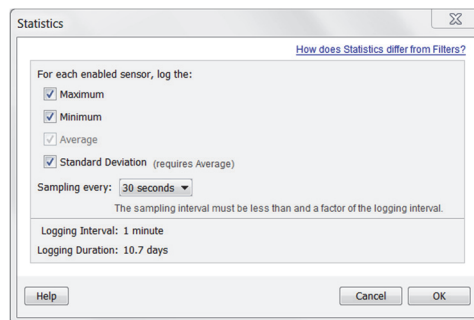

3. Set the sampling interval, which must be less than and a factor of the logging interval. Choose either a preset sampling interval or select Custom and enter your own sampling interval. Keep in mind that the more frequent the sampling rate, the greater the impact on battery life.
4. Click OK when done. This will return you to the Launch Logger window. Click the Edit button next to Logging Mode in the Launch Logger window to make additional changes.

Once logging begins, click the Alarm/Stats button on the logger to cycle through the current maximum, minimum, average, and standard deviation data on the LCD screen. You can plot the statistics series once you read out the logger.

## Reading Out the Logger

There are two options for reading out the logger: connect it to the computer with a USB cable and read out it with HOBOWare, or connect it to a HOBO U-Shuttle (U-DT-1, firmware version 1.18m030 or higher) and then offload the data files from the U-Shuttle to HOBOWare. Refer to the HOBOWare Help for more details.

## Recording Internal Logger Events

The logger records the following internal events to track logger operation and status. You can plot these events in HOBOWare after reading out the logger and opening the data file.

Internal Event Name	Definition
Host Connected	The logger was connected to the computer.
Started	The Start/Stop button was pressed to begin logging.
Stopped	The logger received a command to stop recording data (from HOBOWare or by pushing the Start/Stop button).
Button Up/Button Down	The Start/Stop button was pressed for 1 second.
Chan <#> Alarm Tripped	A sensor alarm has tripped; # is the channel or sensor number as shown in the Launch Logger window in HOBOWare.

Internal Event Name	Definition
Chan <#> Alarm Cleared	A sensor alarm has cleared; # is the channel or sensor number as shown in the Launch Logger window in HOBOWare. This event also contains the value that was furthest out of range for the sensor before the alarm cleared.
New Interval	The logger has entered or exited burst logging mode.
Safe Shutdown	The battery level dropped below 2.5 V; the logger performs a safe shutdown.

### Mounting the Logger

There are several ways to mount the logger using the materials included:

- Use the four built-in magnets on the back of the logger to mount it to a magnetic surface.
- Attach the Command strip to the back of the logger to mount it a wall or other flat surface.
- Use the double-sided tape to affix the logger to a surface.
- Insert the hook-and-loop strap through the mounting loops on both sides of the logger to mount it to a curved surface, such as a pipe or tubing.

### Protecting the Logger

The logger is designed for indoor use and can be permanently damaged by corrosion if it gets wet. Protect it from condensation. If the message FAIL CLK appears on the LCD screen, there was a failure with the internal logger clock possibly due to condensation. Remove the battery immediately and dry the circuit board.

**Note: Static electricity may cause the logger to stop logging.**

The logger has been tested to 8 KV, but avoid electrostatic discharge by grounding yourself to protect the logger. For more information, search for “static discharge” on [www.onsetcomp.com](http://www.onsetcomp.com).

### Replacing the RH Sensor

The internal RH sensor may require replacement if it is damaged mechanically or by exposure to condensation or chemicals. The replacement sensor is available from Onset (HUM-UPS-500). To replace the sensor:

1. Use a screwdriver to pop out the louvered door in the logger case.

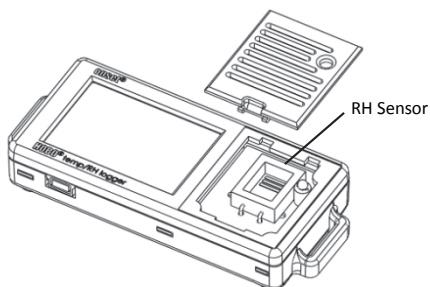

2. Use needle-nose pliers to remove the RH sensor from the board inside the logger case and discard it.
3. Insert the new sensor so that the pins are in the two holes on the board (shown here enlarged and without the logger case for illustrative purposes).

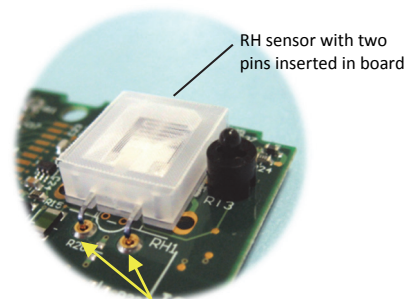

4. Snap the louvered door back into place in the logger.
5. Check logger status in HOBOWare to verify the RH reading.

### Battery Information

The logger contains a 3V CR2032 battery (HRB-TEMP). Expected battery life varies based on the ambient temperature where the logger is deployed, the logging or sampling interval, frequency of offloading to the computer, number of channels that are active, if burst or statistics logging modes are active, and battery performance. A new battery typically lasts 1 year with logging intervals greater than 1 minute. Deployments in extremely cold or hot temperatures, a logging interval faster than 1 minute, or a sampling interval faster than 15 seconds can impact battery life. Estimates are not guaranteed due to uncertainties in initial battery conditions and operating environment.

The logger can also be powered by the USB cable when the remaining battery voltage is too low for it to continue logging. Connect the logger to the computer, click the Readout button on the toolbar, and save the data as prompted. Replace the battery before launching the logger again.

To replace the battery:

1. Holding the logger with the LCD screen facing up, pull the battery tray out of the logger housing.

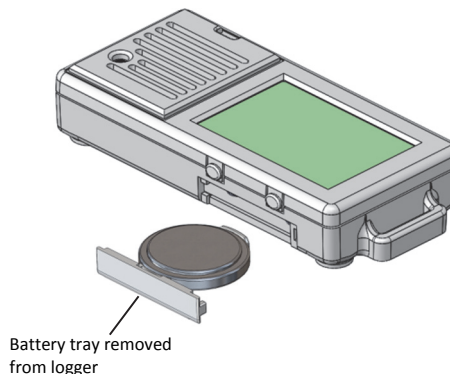

2. Remove the old battery from the tray.
3. Place the new battery in the tray with the positive side facing down.

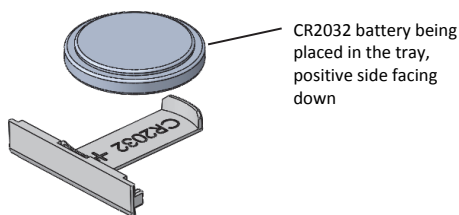

4. With the LCD screen still facing up, slide the tray back into the logger. The LCD should display “HOBO” briefly after correctly installing the battery.

**⚠ WARNING:** Do not cut open, incinerate, heat above 85°C (185°F), or recharge the lithium battery. The battery may explode if the logger is exposed to extreme heat or conditions that could damage or destroy the battery case. Do not dispose of the logger or battery in fire. Do not expose the contents of the battery to water. Dispose of the battery according to local regulations for lithium batteries.

HOBOWare provides the option of recording the current battery voltage at each logging interval, which is disabled by default. Recording battery life at each logging interval takes up memory and therefore reduces logging duration. It is recommended you only record battery voltage for diagnostic purposes.