

HOBOnet® MX2300 Series Data Logger Manual



MX2301A Model Shown

HOBOnet MX2300 Series Data Logger

Models:

- MX2301A, temp/RH
- MX2302A, ext temp/RH
- MX2303, 2 ext temp
- MX2304, ext temp
- MX2305, temp

Included Items:

- Screws
- Cable ties

Required Items:

- HOBOnet app
- Mobile device with Bluetooth and iOS, iPadOS®, or Android™, or a Windows computer with a native BLE adapter or supported BLE dongle

Accessories:

- Solar radiation shield (RS3-B for use with MX2302A, MX2303, and MX2304 models; RS1 or M-RSA for use with MX2301A and MX2305 models)
- Mounting bracket for solar radiation shield (MX2300-RS-BRACKET), for use with MX2301A and MX2305 models
- Replacement battery (HRB-2/3AA)

The HOBOnet MX2300 series data loggers record and transmit temperature and/or relative humidity (RH) in outdoor or indoor environments. These Bluetooth® Low Energy (BLE)-enabled loggers are designed for wireless communication with a phone, tablet, or computer. Using the HOBOnetconnect® app, you can easily configure the logger and then download logged data to view or export for further analysis. The logger can calculate minimum, maximum, average, and standard deviation statistics and be configured to indicate alarms at thresholds you specify. The logger also supports burst logging in which data is logged at a faster interval when sensor readings are above or below certain limits. The Temp and Temp/RH models have internal sensors while the External Temp/RH, External Temp, and 2x External Temp include built-in external sensors, offering a wide range of solutions for monitoring temperature and RH in numerous applications.

Specifications

Temperature Sensor

Range	MX2301A and MX2305 internal sensors: -40 to 70°C (-40 to 158°F) MX2302A external temperature sensor: -40 to 70°C (-40 to 158°F) MX2303 and MX2304 external sensors: -40 to 100°C (-40 to 212°F), with tip and cable immersion in fresh water up to 50°C (122°F) for one year
Accuracy	±0.25°C from -40 to 0°C (±0.45 from -40 to 32°F) ±0.2°C from 0 to 70°C (±0.36 from 32 to 158°F) ±0.25°C from 70 to 100°C (±0.45 from 158 to 212°F), MX2303 and MX2304 only
Resolution	MX2301A and MX2302A: 0.02°C (0.036°F) MX2303, MX2304, and MX2305: 0.04°C (0.072°F)
Drift	<0.01°C (0.018°F) per year



Relative Humidity Sensor* (MX2301A, MX2302A only)

Range	0 to 100% RH, -40° to 70°C (-40° to 158°F); exposure to conditions below -20°C (-4°F) or above 95% RH may temporarily increase the maximum RH sensor error by an additional 1%
Accuracy	±2.5% from 10% to 90% (typical) to a maximum of ±3.5% including hysteresis at 25°C (77°F); below 10% RH and above 90% RH ±5% typical
Resolution	0.01%
Drift	<1% per year typical

Response Time (typical, to 90% of change)

Temperature	Without Solar Radiation Shield	With RS1/M-RSA Solar Radiation Shield	With RS3-B Solar Radiation Shield
MX2301A internal sensor	17 minutes in air moving 1 m/sec	24 minutes in air moving 1 m/sec	NA
MX2302A external sensor	3 minutes, 45 seconds in air moving 1 m/sec	7 minutes, 45 seconds in air moving 1 m/sec	6 minutes, 30 seconds in air moving 1 m/sec
MX2303/MX2304 external sensors	3 minutes in air moving 1 m/sec; 20 seconds in stirred water	7 minutes in air moving 1 m/sec	4 minutes in air moving 1 m/sec
MX2305 internal sensor	17 minutes in air moving 1 m/sec	24 minutes in air moving 1 m/sec	NA
RH	Without Solar Radiation Shield	With RS1/M-RSA Solar Radiation Shield	With RS3-B Solar Radiation Shield
MX2301A internal sensor	30 seconds in air moving 1 m/sec	40 seconds in air moving 1 m/sec	NA
MX2302A external sensor	15 seconds in air moving 1 m/sec	30 seconds in air moving 1 m/sec	30 seconds in air moving 1 m/sec

Specifications (continued)

Logger	
Operating Range	-40° to 70°C (-40° to 158°F)
Radio Power	1 mW (0 dBm)
Transmission Range	Approximately 30.5 m (100 ft) line-of-sight
Wireless Data Standard	Bluetooth Low Energy (Bluetooth Smart)
Logging Rate	1 second to 18 hours
Logging Modes	Fixed interval (normal, statistics) or burst
Memory Modes	Wrap when full or stop when full
Start Modes	Immediate, push button, date & time, or next interval
Stop Modes	When memory full, push button, date & time, or after a set logging period
Time Accuracy	±1 minute per month 0° to 50°C (32° to 122°F)
Battery Type	2/3 AA 3.6 Volt lithium, user replaceable
Battery Life	2 years, typical with logging interval of 1 minute and Bluetooth Always On enabled; 5 years, typical with logging interval of 1 minute and Bluetooth Always On disabled. Faster logging intervals and statistics sampling intervals, burst logging, remaining connected with the app, excessive downloads, and paging may impact battery life.
Memory	MX2301A and MX2302A: 128 KB (63,488 measurements, maximum) MX2303, MX2304, and MX2305: 128 KB (84,650 measurements, maximum)
Full Memory Download Time	Approximately 60 seconds; may take longer the further the device is from the logger
Dimensions	Logger housing: 10.8 x 5.08 x 2.24 cm (4.25 x 2.0 x 0.88 in.) External temperature sensor diameter: 0.53 cm (0.21 in.) External temperature/RH sensor diameter: 1.17 cm (0.46 in.) External sensor cable length: 2 m (6.56 ft) Solar radiation shield bracket: 10.8 x 8.3 cm (4.25 X 3.25 in.)
Weight	Logger: 75.5 g (2.66 oz) Solar radiation shield bracket: 20.4 g (0.72 oz)
Materials	Acetal, silicone gasket, stainless steel screws
Environmental Rating	NEMA 6 and IP67
	The CE Marking identifies this product as complying with all relevant directives in the European Union (EU).
	See last page

*Per RH sensor manufacturer data sheet

Logger Components and Operation

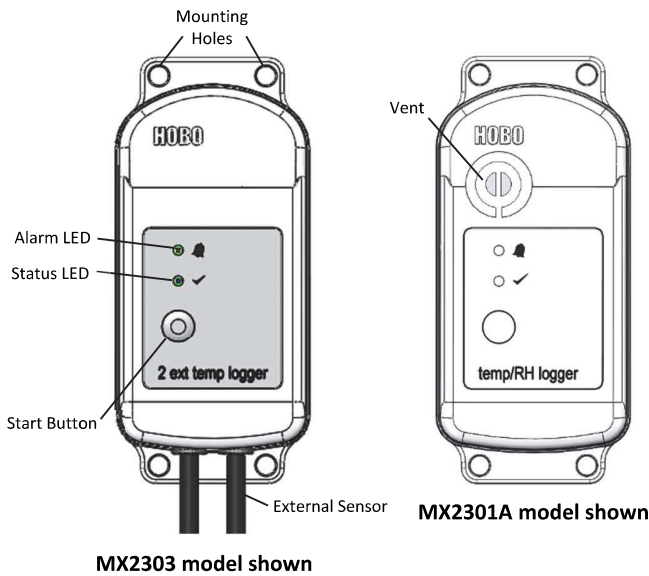

Mounting Holes: Use the holes at the top and bottom of the logger to mount it (see *Deploying and Mounting the Logger*).

Alarm LED: This LED blinks red every 4 seconds when an alarm is tripped (unless Show LED is disabled as described in *Configuring the Logger*).

Status LED: This LED blinks blue every 4 seconds when the logger is logging (unless Show LED is disabled as described in *Configuring the Logger*). If the logger is waiting to start logging because it was configured to start On Button Push or with a delayed start, it blinks every 8 seconds.

Start Button: Press this button to wake up the logger; both the alarm and status LEDs blink. Once the logger is awake, press this button to move its tile to the top of the devices list in the app. Press this button for 3 seconds to start or stop the logger when it is configured to start or stop On Button Push (see *Configuring the Logger*). Both LEDs blink four times when you press the button to start or stop logging. Press this button for 10 seconds to reset a password (see *Setting a Password*).

External Sensor: This is the external probe attached to the bottom of the logger that measures temperature or temperature/RH. The MX2302A logger has one external sensor that measures both temperature and RH and the MX2304 logger has one sensor that measures temperature only. The MX2303 logger (shown at left above) has two external temperature sensors; the left sensor is channel 1 and the right sensor is channel 2.

Vent: The RH sensor is located behind the vent (MX2301A model only).

Downloading the App and Connecting to a Logger

Install the app to connect to and work with the logger.

1. Download HOBObconnect to a phone or tablet from the App Store® or Google Play™.
Download the app to a Windows computer from www.onsetcomp.com/products/software/hobobconnect.

2. Open the app and enable Bluetooth in the device settings if prompted.
3. Press the button on the logger to wake it up.
4. Tap Devices and then tap the logger tile in the app to connect to it.

If the logger does not appear or if it is having trouble connecting, follow these tips:

- Make sure the logger is awake by pressing the start button. The alarm and status LEDs blink once when the logger wakes up. You can also press the button a second time to bring it to the top of the list if you are working with multiple loggers.
- Make sure the logger is within range of your mobile device or computer. The range for successful wireless communication is approximately 30.5 m (100 ft) with full line-of-sight.
- If there are several loggers in the area, move the logger to a location with fewer loggers. Interference sometimes occurs when numerous loggers are in one location.
- If your device can connect to the logger intermittently or loses its connection, move closer to the logger, within sight if possible.
- If the logger appears in the app, but you cannot connect to it, close the app and then power down your device to force the previous Bluetooth connection to close.

Once the logger is connected, you can:

Tap this:	To do this:
	Specify logger settings and save them to the logger to start logging. See <i>Configuring the Logger</i> .
	Download logger data. See <i>Downloading Data From the Logger</i> .
	Start logging if the logger is configured to start On Button Push. See <i>Configuring the Logger</i> .
	Stop logging data (this overrides any Stop Logging settings described in <i>Configuring the Logger</i>).
	Illuminate the logger LEDs for 4 seconds.
	Set a password for the logger that is required when another mobile device attempts to connect to it. To reset a password, press the button on the logger for 10 seconds or tap Manage Password and tap Reset.
	Mark the logger as a favorite. You can then filter the list of devices to show only loggers marked as favorites.



Update the firmware on the logger. A logger download is completed automatically at the beginning of the firmware update process.

Important: Before updating the firmware on the logger, check the remaining battery level and make sure it is no less than 30%. Make sure you have the time to complete the entire update process, which requires that the logger remains connected to the device during the upgrade.

Configuring the Logger

Use the app to set up the logger, including selecting the logging options, configuring alarms, and other settings. These steps provide an overview of setting up the logger. For complete details, see the HOBOnnect User's Guide.

Note: Edit only the settings you want to change. If you do not edit a setting, the logger uses the current setting.

1. Tap Devices and then tap the logger to connect to it. If the logger was configured with Bluetooth Always On disabled, firmly press the button on the logger to wake it up. This also brings the logger to the top of the logger list.
2. Tap Configure & Start to configure the logger.
3. Tap Name and type a name for the logger (optional). If you do not enter a name, the app uses logger serial number as the name.
4. Tap Group to add the logger to a group (optional).
5. Tap Logging Interval and choose how frequently the logger records data when not in burst logging mode (see *Burst Logging*).

Note: If you configure an alarm, the logger will use the logging interval you selected as the rate to check for alarm conditions (alarms are not available if burst logging is configured). See *Setting up Alarms* for more details.

6. Tap Start Logging and select when logging begins:
 - **On Save.** Logging begins immediately after configuration settings are saved.
 - **On Next Interval.** Logging begins at the next even interval as determined by the selected logging interval setting.
 - **On Button Push.** Logging begins when you press the circle on the logger for 3 seconds.
 - **On Date/Time.** Logging begins at a date and time you specify. Specify the date and time.
7. Tap Stop Logging and specify when logging ends.
 - **Never Stop (Overwrites Old Data).** The logger does not stop at any predetermined time. The logger continues recording data indefinitely, with newest data overwriting the oldest.
 - **On Date/Time.** The logger stops logging on a specific date and time that you specify.
 - **After.** Select this if you want to control how long the logger should continue logging once it starts. Choose the amount of time you want the logger to log data.

For example, select 30 days if you want the logger to log data for 30 days after logging begins.

- **Stop When Memory Fills.** The logger continues recording data until the memory is full.
8. Tap Pause Options, then select Pause On Button Push to specify that you can pause the logger by pressing its button for 3 seconds.
 9. Tap Logging Mode. Select either Fixed or Burst logging. Fixed logging records data for all enabled sensors and/or selected statistics at the logging interval selected (see *Statistics Logging* for details on choosing statistics options). Burst mode logs at a different interval when a specified condition is met. See *Burst Logging* for more information.
 10. Enable or disable Show LED. If Show LED is disabled, the alarm and status LEDs on the logger do not illuminate while logging (the alarm LED does not blink if an alarm trips). You can temporarily turn on LEDs when Show LED is disabled by pressing the circle on the logger for 1 second.
 11. Enable or disable Bluetooth Always On. When this option is enabled, the logger advertises or regularly sends out a Bluetooth signal for the phone, tablet, or computer to find via the app while it is logging, which uses battery power. When this option is disabled, the logger advertises only during logging when you press the button on the logger to wake it up. This preserves battery power.
 12. Select the sensor measurement types that you want to log. Both the temperature and RH sensors are required to calculate the dew point, which is an additional data series available for plotting after reading out the logger. You can also set up alarms to trip when a sensor reading rises above or falls below a specified value. See *Setting up Alarms* for details on enabling sensor alarms. **Note for MX2303 models only:** The first temperature sensor listed is channel 1 and the second is channel 2 (and "-1" and "-2" is used in the column headings in the data file to differentiate the two sensors). Set up alarms to trip when a sensor reading rises above or falls below a specified value. See *Setting up Alarms* for details on enabling sensor alarms.
 13. Tap Start to save the configuration settings and start logging.

Logging begins based on the settings you specified. Press the start button on the logger if you set it up to start logging with a button push. See *Deploying and Mounting the Logger* for details on mounting and see *Downloading Data From the Logger* for details on downloading.

Setting up Alarms

You can set up alarms for the logger so that if a sensor reading rises above or falls below a specified value, the logger alarm LED blinks and an alarm icon appears in the app. This alerts you to problems so you can take corrective action.

To set an alarm:

1. Tap Devices. Press the button on the logger to wake it up, if necessary.
2. Tap the logger tile in the app to connect to the logger and tap Configure & Start.
3. Tap a Sensor/Channel.
4. Tap Enable Logging, if necessary.

5. Tap Alarms to open that area of the screen.
6. Select Low if you want an alarm to trip when the sensor reading falls below the low alarm value. Enter a value to set the low alarm value.
7. Select High if you want an alarm to trip when the sensor reading rises above the high alarm value. Enter a value to set the high alarm value.
8. For the Duration, select how much time should elapse before the alarm trips and select one of the following:
 - **Cumulative Samples.** The alarm trips once the sensor reading is out of the acceptable range for the selected duration any time during logging. For example, if the high alarm is set to 85°F and the duration is set to 30 minutes, then the alarm trips once the sensor readings have been above 85°F for a total of 30 minutes since the logger was configured.
 - **Consecutive Samples.** The alarm trips once the sensor reading is out of the acceptable range continuously for the selected duration. For example, the high alarm is set to 85°F and the duration is set to 30 minutes, then the alarm trips only if all sensor readings are 85°F or above for a continuous 30-minute period.
9. Repeat steps 2–8 for the other sensor.
10. In the configuration settings, select one of the following options to determine how to clear the alarm indicators:
 - **Logger Reconfigured.** The alarm indicator is displayed until the next time the logger is reconfigured.
 - **Sensor in Limits.** The alarm icon indicator is displayed until the sensor reading returns to the normal range between any configured high and low alarm limits.

When an alarm trips, the logger alarm LED blinks every 4 seconds (unless Show LED is disabled), an alarm icon appears in the app, and an Alarm Tripped event is logged. The alarm state clears when the readings return to normal if you selected Sensor in Limits in step 10. Otherwise, the alarm state remains in place until the logger is reconfigured.

Notes:

- Alarm limits are checked at every logging interval. For example, if the logging interval is set to 5 minutes, then the logger checks the sensor readings against your configured high and low alarm setting every 5 minutes.
- The actual values for the high and low alarm limits are set to the closest value supported by the logger. In addition, alarms can trip or clear when the sensor reading is within the resolution specifications.
- When you download data from the logger, alarm events can be displayed on the plot or in the data file. See *Logger Events*.

Burst Logging

Burst logging is a logging mode that allows you to set up more frequent logging when a specified condition is met. For example, a logger is recording data at a 5-minute logging interval and burst logging is configured to log every 30 seconds when the temperature rises above 85°F (the high limit) or falls below 32°F (the low limit). This means the logger records data every 5 minutes as long as the temperature remains between 85°F and 32°F. Once the temperature rises above 85°F, the

logger switches to the faster logging rate and records data every 30 seconds until the temperature falls back to 85°F. At that time, logging resumes every 5 minutes at the fixed logging interval. Similarly, if the temperature falls below 32°F, the logger switches to burst logging mode again and records data every 30 seconds. Once the temperature rises back to 32°F, the logger returns to fixed mode, logging every 5 minutes. **Note:** Sensor alarms, statistics, and the Stop Logging option Never Stop (Overwrites Old Data) are not available in burst logging mode.

To set up burst logging:

1. Tap Devices. Press the Start/Stop button on the logger to wake it up, if necessary.
2. Tap the logger tile in the app to connect to the logger and tap Configure & Start.
3. Tap Logging Mode and then tap Burst Logging.
4. Set the burst logging interval, which must be faster than the logging interval. Keep in mind that the faster the burst logging rate, the greater the impact on battery life and the shorter the logging duration. Because measurements are being taken at the burst logging interval throughout the deployment, the battery usage is similar to what it would be if you had selected this rate for the normal logging interval.
5. Select Low and/or High and type a value to set the low and/or high values.
6. Repeat step 5 for the other sensor if desired.

Notes:

- The high and low burst limits are checked at the burst logging interval rate whether the logger is in normal or burst condition. For example, if the logging interval is set to 1 hour and the burst logging interval is set to 10 minutes, the logger always checks for burst limits every 10 minutes.
- If high and/or low limits are configured for more than one sensor, burst logging begins when any high or low condition goes out of range. Burst logging does not end until all conditions on all sensors are back within normal range.
- The actual values for the burst logging limits are set to the closest value supported by the logger.
- Burst logging can begin or end when the sensor reading is within the resolution specifications. This means the value that triggers burst logging may differ slightly from the value entered.
- Once the high or low condition clears, the logging interval time is calculated using the last recorded data point in burst logging mode, not the last data point recorded at the normal logging rate. For example, the logger has a 10-minute logging interval and logged a data point at 9:05. Then, the high limit is surpassed and burst logging begins at 9:06. Burst logging then continues until 9:12 when the sensor reading falls back below the high limit. Now back in fixed mode, the next logging interval is 10 minutes from the last burst logging point, or 9:22 in this case. If burst logging had not occurred, the next data point would have been at 9:15.
- A New Interval event is created each time the logger enters or exits burst logging mode. See *Logger Events* for

details on plotting and viewing the event. In addition, if you stop the logger with a button push while in burst logging mode, a New Interval event is automatically logged and the burst condition is cleared, even if the actual high or low condition has not cleared.

Statistics Logging

During fixed logging, the logger records data for enabled sensors and/or selected statistics at the logging interval selected. Statistics are calculated at a sampling rate you specify with the results for the sampling period recorded at each logging interval. You can log the following statistics for each sensor:

- The maximum, or highest, sampled value
- The minimum, or lowest, sampled value
- An average of all sampled values
- The standard deviation from the average for all sampled values

For example, a logger is configured with both the temperature and RH sensors enabled, and the logging interval set to 5 minutes. The logging mode is set to fixed logging with all four statistics enabled and with a statistics sampling interval of 30 seconds. Once logging begins, the logger measures and records the actual temperature and RH sensor values every 5 minutes. In addition, the logger takes a temperature and RH sample every 30 seconds and temporarily stores them in memory. The logger then calculates the maximum, minimum, average, and standard deviation using the samples gathered over the previous 5-minute period and logs the resulting values. When downloading data from the logger, this results in 10 data series (not including any derived series, such as dew point): two sensor series (with temperature and RH data logged every 5 minutes) plus eight maximum, minimum, average, and standard deviation series (four for temperature and four for RH with values calculated and logged every 5 minutes based on the 30-second sampling).

To log statistics:

1. Tap Devices. Press the Start/Stop button **on the logger** to wake it up, if necessary.
2. Tap the logger tile in the app to connect to the logger and tap Configure & Start.
3. Tap Logging Mode and select Fixed Logging Mode.
4. Tap to turn on Statistics.

Note: Fixed Logging Mode records sensor measurements taken at each logging interval. The selections you make in the Statistics section add measurements to the recorded data.
5. Select the statistics you want the logger to record at each logging interval: Maximum, Minimum, Average, and Standard Deviation (average is automatically enabled when selecting Standard Deviation). Statistics are logged for all enabled sensors. In addition, the more statistics you record, the shorter the logger duration and the more memory is required.
6. Enter a value in Statistics Sampling Interval to use for calculating statistics. The rate must be less than, and a factor of, the logging interval. For example, if the logging

interval is 1 minute and you select 5 seconds for the sampling rate, the logger takes 12 sample readings between each logging interval (one sample every 5 seconds for a minute) and use the 12 samples to record the resulting statistics at each 1-minute logging interval. Note that the faster the sampling rate, the greater the impact on battery life. Because measurements are being taken at the statistics sampling interval throughout the deployment, the battery usage is similar to what it would be if you had selected this rate for the normal logging interval.

Setting a Password

You can create an encrypted password for the logger that is required if another device attempts to connect to it. This is recommended to ensure that a deployed logger is not mistakenly stopped or purposely altered by others. This password uses a proprietary encryption algorithm that changes with every connection.

To set a password:

1. Tap Devices. Press the Start/Stop button **on the logger** to wake it up, if necessary. Tap the logger tile in the app to connect to it.
2. Tap Lock Logger.
3. Type a password and then tap Set.

Only the device used to set the password can then connect to the logger without entering a password; all other devices are required to enter the password. For example, if you set the password for the logger with your tablet and then try to connect to the logger later with your phone, you must enter the password on the phone but not with your tablet. Similarly, if others attempt to connect to the logger with different devices, they are also required to enter the password. To reset a password, press the circle on the logger for 10 seconds or connect to the logger and tap Manage Password and tap Reset.

Downloading Data From the Logger

To download data from the logger:



1. Tap Devices. Press the circle **on the logger** to wake it up, if necessary. Tap the logger tile in the app to connect to the logger.
2. Tap Download Data. The logger downloads data to the phone, tablet, or computer.
3. Once the download is complete, tap Done to return to the previous page or tap Export and Share to save the file in the specified format.
4. When the export file has successfully been created, tap Done to return to the previous page or tap Share to use your device's usual modes of sharing.

You can also upload data automatically to HOBOLink, Onset's web-based software, using the app or the MX gateway. For details, see the HOBOLink User Guide and see the HOBOLink help for details on working with data in HOBOLink.

Logger Events

The logger records the following internal events to track logger operation and status. You can view events in exported files or plot events in the app.

To plot events, tap HOBO Files and select a file to open.

Tap  (if applicable) and then tap . Select the events you want to plot and tap OK.

Internal Event Name	Definition
Host Connected	The logger was connected to the mobile device.
Started	The logger started logging.
Stopped	The logger stopped logging.
Alarm Tripped/Cleared	An alarm has occurred because the reading was outside the alarm limits or back within range. Note: Although the reading may have returned to a normal range during logging, an alarm cleared event will not be logged if the logger was set up to maintain alarms until reconfigured.
New Interval	The logger has switched to logging at the burst logging rate or back to the normal rate.
Safe Shutdown	The battery level dropped below a safe operating voltage and the logger performed a safe shutdown.

- When deploying an MX2302A logger, it is recommended that the sensor must be mounted vertically. If it must be mounted horizontally, then make sure the vent on the side of the sensor is vertical or facing down. If the sensor is being deployed in an RS3-B solar radiation shield, mount it vertically as shown below.

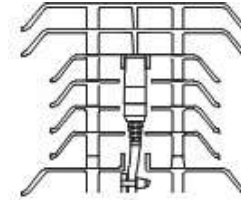

- When deploying a logger with external sensors (MX2302A, MX2303, and MX2304), mount the logger so the sensor cable is not being pulled. Leave about 5 cm (2 in.) of drip loop in the cable where it comes out of the logger to prevent water from entering the logger housing.

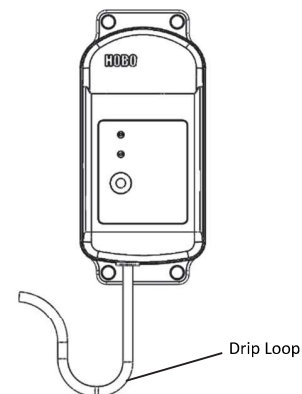

Deploying and Mounting the Logger

Follow these guidelines when deploying the logger:

- A solar radiation shield is required if the MX2301A or MX2305 logger or the external sensors from an MX2302A, MX2303, or MX2304 logger will be in sunlight at any time.
- When using a solar radiation shield with an MX2301A or MX2305 model, the logger must be mounted using the solar radiation shield bracket (MX2300-RS-BRACKET) to the underside of the mounting plate as shown.

For more details on the solar radiation shield, refer to the *Solar Radiation Shield Installation Guide* at www.onsetcomp.com/manuals/rs1.

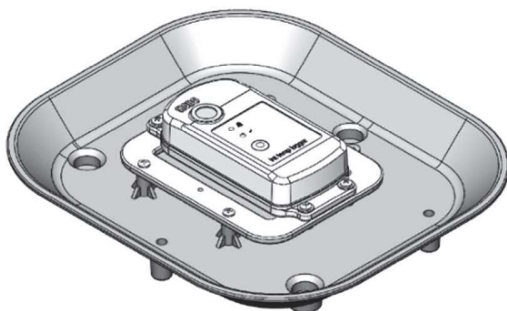

- For MX2301A and MX2305 loggers that are not being deployed with a solar radiation shield or for loggers with external sensors (MX2302A, MX2303, and MX2304), you can either use the included large screws or cable ties to mount the logger via the mounting holes. Use the screws to attach the logger to a wall or flat surface. Use the cable ties to affix the logger to a PVC pipe or mast. The MX2301A logger must also be mounted vertically or with the sensor vent facing down when not using the solar radiation shield.

Protecting the Logger

Note: Static electricity may cause the logger to stop logging.

The logger has been tested to 8 KV, but avoid electrostatic discharge by grounding yourself to protect the logger. For more information, search for “static discharge” on onsetcomp.com.

Battery Information

The logger requires one user-replaceable 2/3 AA 3.6 V lithium battery (HRB-2/3AA). Battery life is 2 year, typical with a logging

interval of 1 minute, but may be extended to 5 years when the logger is configured with Bluetooth Always On disabled. Expected battery life varies based on the ambient temperature where the logger is deployed, the logging or sampling interval, frequency of offloading and connecting to the mobile device, number of channels that are active, and use of burst mode or statistics logging. Deployments in extremely cold or hot temperatures or logging interval faster than 1 minute can impact battery life. Estimates are not guaranteed due to uncertainties in initial battery conditions and operating environment.

To install or replace the battery:

1. Use a Phillips-head screwdriver to unscrew the four screws from the back of the logger.

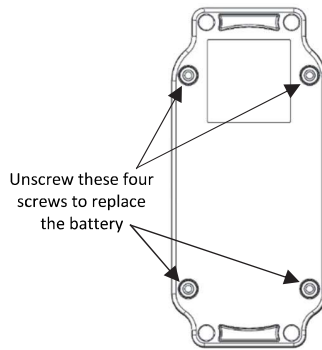

2. Carefully separate the top and bottom of the logger enclosure.

3. Remove the old battery and insert the new battery observing polarity. It is recommended that you replace the desiccant (DESICCANT2) when replacing the battery.
4. Make sure the rubber seal is clean and free of any debris and then carefully reassemble the logger enclosure and screw in the four screws.

⚠ WARNING: Do not cut open, incinerate, heat above 85°C (185°F), or recharge the lithium battery. The battery may explode if the logger is exposed to extreme heat or conditions that could damage or destroy the battery case. Do not dispose of the logger or battery in fire. Do not expose the contents of the battery to water. Dispose of the battery according to local regulations for lithium batteries.

Federal Communication Commission Interference Statement

This equipment has been tested and found to comply with the limits for a Class B digital device, pursuant to Part 15 of the FCC Rules. These limits are designed to provide reasonable protection against harmful interference in a residential installation. This equipment generates uses and can radiate radio frequency energy and, if not installed and used in accordance with the instructions, may cause harmful interference to radio communications. However, there is no guarantee that interference will not occur in a particular installation. If this equipment does cause harmful interference to radio or television reception, which can be determined by turning the equipment off and on, the user is encouraged to try to correct the interference by one of the following measures:

- Reorient or relocate the receiving antenna
- Increase the separation between the equipment and receiver
- Connect the equipment into an outlet on a circuit different from that to which the receiver is connected
- Consult the dealer or an experienced radio/TV technician for help

This device complies with Part 15 of the FCC Rules. Operation is subject to the following two conditions: (1) This device may not cause harmful interference, and (2) this device must accept any interference received, including interference that may cause undesired operation.

FCC Caution: Any changes or modifications not expressly approved by the party responsible for compliance could void the user's authority to operate this equipment.

Industry Canada Statements

This device complies with Industry Canada license-exempt RSS standard(s). Operation is subject to the following two conditions: (1) this device may not cause interference, and (2) this device must accept any interference, including interference that may cause undesired operation of the device.

Avis de conformité pour l'Industrie Canada

Le présent appareil est conforme aux CNR d'Industrie Canada applicables aux appareils radio exempts de licence. L'exploitation est autorisée aux deux conditions suivantes : (1) l'appareil ne doit pas produire de brouillage, et (2) l'appareil doit accepter tout brouillage radioélectrique subi, même si le brouillage est susceptible d'en compromettre le fonctionnement.

To comply with FCC and Industry Canada RF radiation exposure limits for general population, the logger must be installed to provide a separation distance of at least 20cm from all persons and must not be co-located or operating in conjunction with any other antenna or transmitter.

KC Statement

해당 무선설비는 전파혼신 가능성이 있으므로 인명안전과 관련된 서비스는 할 수 없음

Translation:

The service related to human safety is not allowed because this device may have the possibility of the radio interference.